

Top 100  
Global  
Innovator  
for 10 years

**Metasol** *Meta Solution*

# MANUAL MOTOR STARTERS



**LS** *ELECTRIC*

**Metasol** *Meta Solution*

# MANUAL MOTOR STARTERS

More safe through improved short circuit performance, more valuable through added trip function and enhanced quality performance, new solution of motor protection! with enhanced performance, superior durability and global competitiveness

MMS provides high performance for short circuit, overload, and phase failure protection and high durability, to keep your system and load devices safe. It is also a global product that has passed IEC and UL specifications and has been verified for its excellence



MMS-32D

MMS-32S

MMS-32H

MMS-63S



MMS-100H



## Certification

• IEC60947 / UL508 / K 60947 / GB 14048



## Contents

<b>Feature</b>	<b>4</b>
<b>Product Selection Guide</b>	<b>10</b>
<b>Model and Rating</b>	<b>12</b>
• Standard type	12
• High breaking type	13
• Instantaneous type	14
<b>Accessories</b>	<b>15</b>
• Auxiliary contact / Alarm contact	15
• Trip device	16
• Auxiliaries	17
• MMS-32D Auxiliary contact	18
• MMS-32D Shunt release / Undervoltage release / Installation of accessories	19
• Electrical auxiliaries / Possible combination chart	22
<b>Technical Information</b>	<b>23</b>
• Installation and use environment	23
• Installation of auxiliaries	24
• IEC performance data (Motor protection)	29
• Manual motor controller (UL 508, CSA C22.2 as manual motor controllers)	32
• Manual motor controller (UL 508)	34
• Type '2' coordination according to IEC60947-4-1	36
• LS MMS ready for IE3-rated motors	37
• IE3 De-rating table	38
• Characteristic curve	39
• Thermal limit on short-circuit	40
<b>Dimension</b>	<b>43</b>

# New Performance

LS Manual Motor Starters(MMS) is a motor protection product with high performance and reliability. This product has higher technology and expertise than the existing Meta-MEC MMS due to existing overload and phase failure protection functions, upgraded short-circuit capabilities and quality. In addition, all user conditions were met in accordance with IEC and UL standards



## Metasol Manual Motor Starters



### Enhanced trip function

- New application of MMS-32/63 trip indicator enhances the visibility of trip



### Reinforced product reliability

- Reinforced breaking reliability compared to existing Meta-MEC MMS



### Compatibility and design differentiation

- Same external dimension with Meta-MEC MMS
- Consistency with Metasol MC by changing appearance color

### 32AF

#### 0.1~0.16... 28~40A (17 Step)



**MMS-32S**  
• Standard

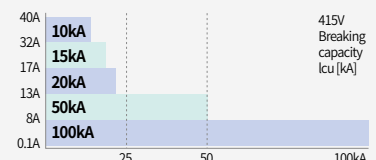

**MMS-32H**  
**MMS-32HI**  
• High break  
• Magnetic release

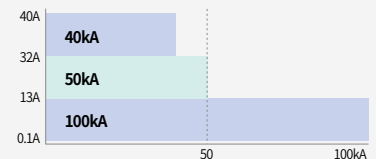



Meta-MEC 63S

Metasol 63S

Meta-MEC 100H

Metasol 100H

63AF

6~10... 47~65A (10 Step)



**MMS-63S**  
• Standard

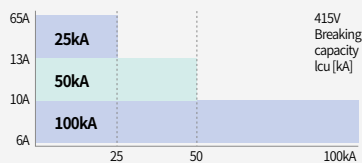

415V  
Breaking capacity I<sub>cu</sub> [kA]



**MMS-63H**  
**MMS-63HI**  
• High break  
• Magnetic release

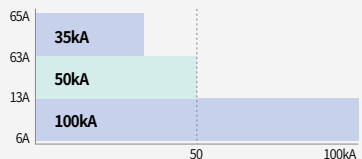

100AF

11~17... 80~100A (10 Step)



**MMS-100S**  
• Standard

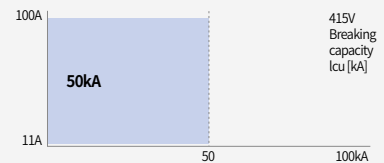

415V  
Breaking capacity I<sub>cu</sub> [kA]



**MMS-100H**  
**MMS-100HI**  
• High break  
• Magnetic release

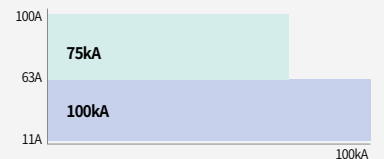

# Multi Function & Compact Size

MMS combines function of MCCB and TOR into one.

Simple and easy wiring, panel size miniaturize. Compact design products of high-function...100kA

## MCCB function

- Over load protection
- Short protection



## TOR function

- Protection function
  - Over load protection
  - Phase failure protection
- Other function
  - Current modification
  - Wide range of ambient temperature compensation



## MMS

(Manual Motor Starter)



## Variety of performance



Function	Notes
Miniaturization	Panel size can be reduced to 50% or less
High breaking capacity	32AF : 50~100kA (Previous 10kA)
Various protection features	Over load, Short circuit, Phase failure protection
Current modification	±20%
Temperature used	-20°C~+60°C
Standard	IEC (60947-1, 2, 4), UL508 (Type E), GB 14048
Size	MMS-32D follows DIN 43880 standards.

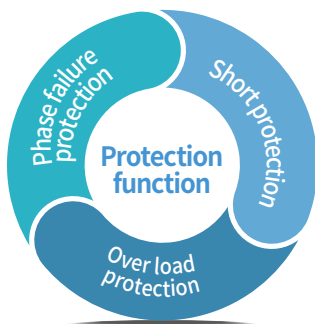

## Feature

- 45mm width(32AF), 55mm width(63AF), 70mm width(100AF)
- Three position operator : On-Off-Trip (Only 100AF is applied)
- Complete range of common accessories
- Handle lock in the Off position
- Class 10 overload trip characteristics
- Trip test
- Finger safe terminal
- Din rail & Screw mounting
- Ready for IE3

# External appearance

Manual Motor Starters

## MMS 32H... 40A [Scale 1:1]

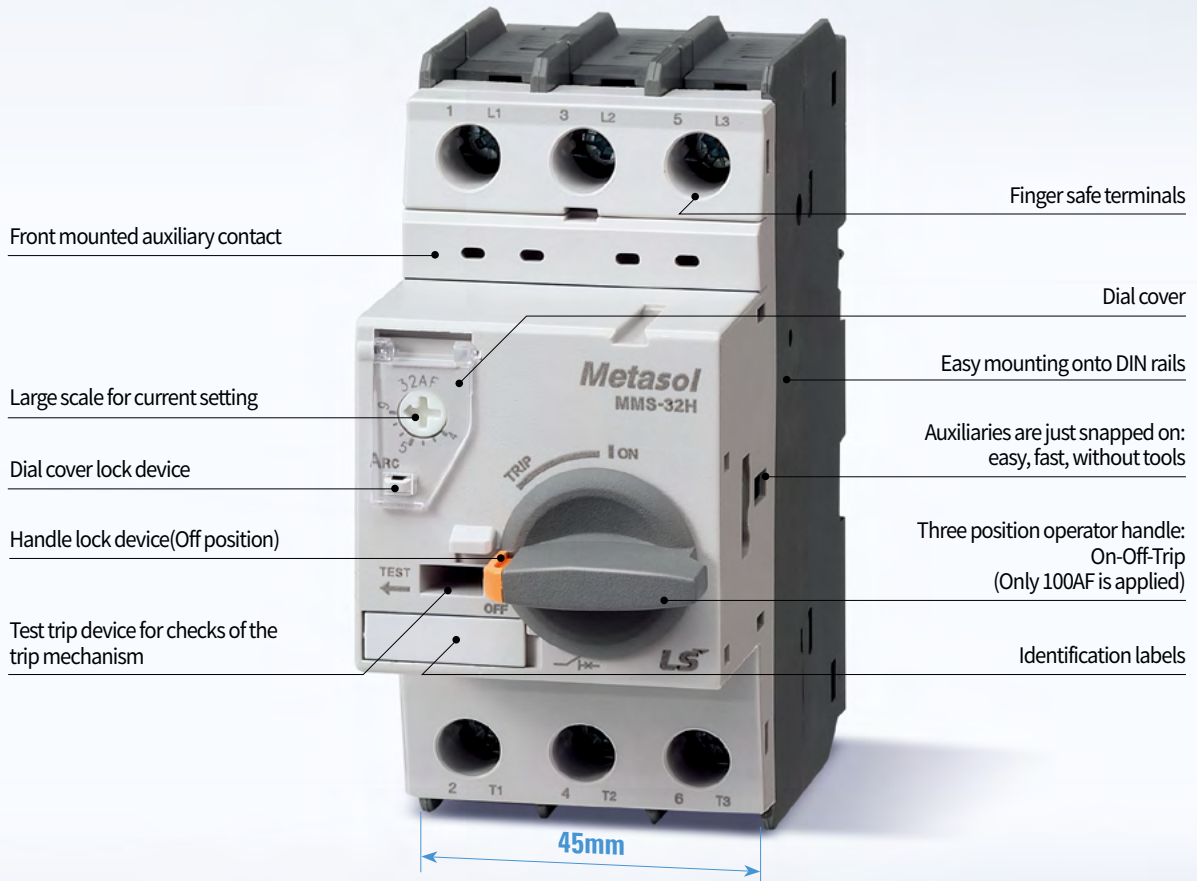

### Handle lock



### Dial cover



### Terminals



MMS-32 (Screw)



MMS-63 (Lug)



MMS-100 (Lug)

# Convenience

Various accessories ... Common up to 100AF

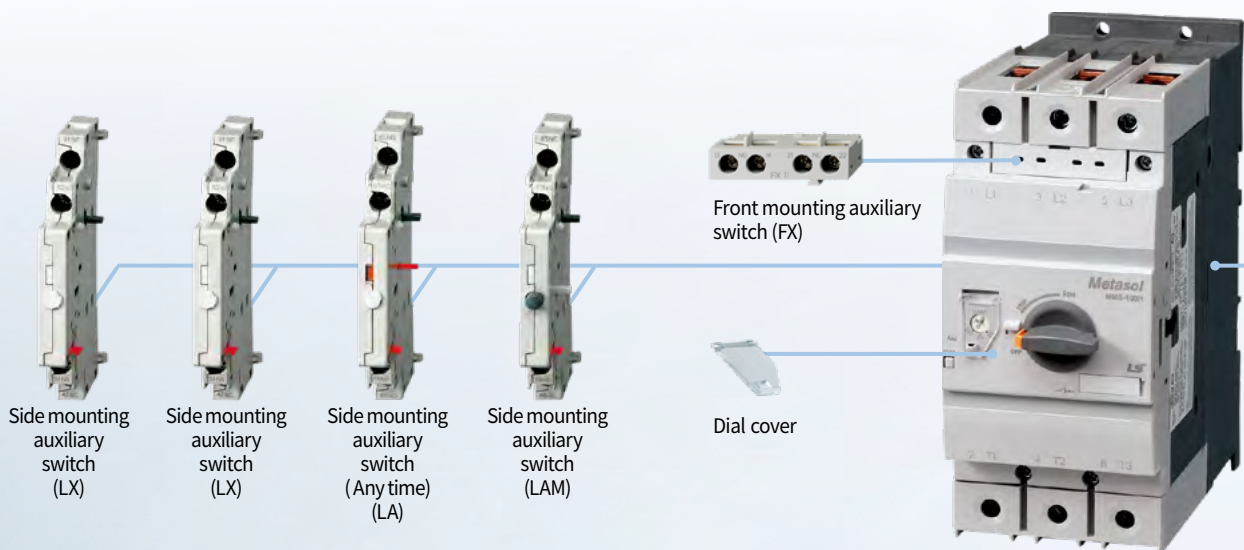
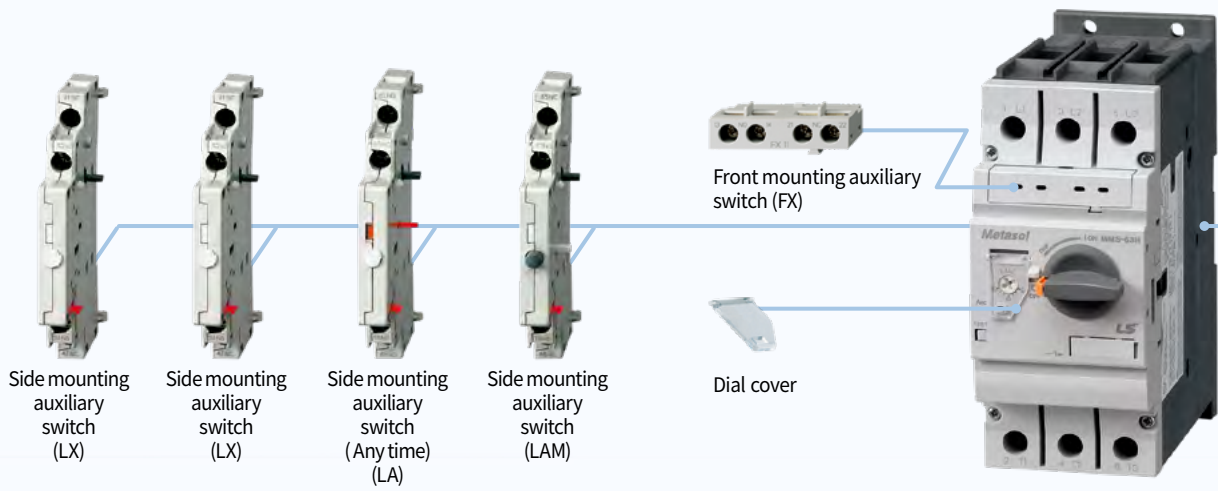
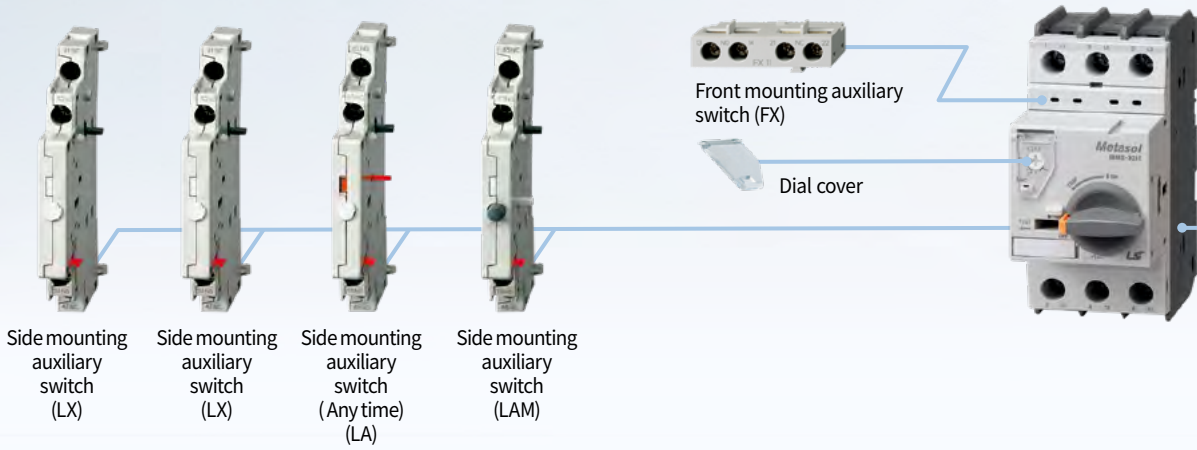



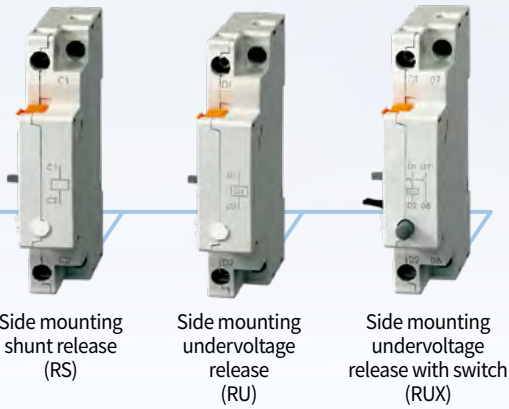

Side mounting shunt release (RS)

Side mounting undervoltage release (RU)

Side mounting undervoltage release with switch (RUX)

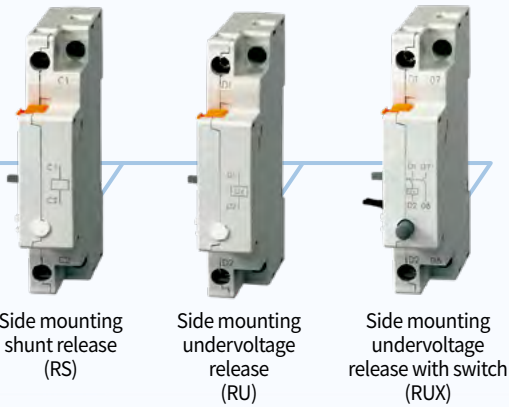

Side mounting shunt release (RS)

Side mounting undervoltage release (RU)

Side mounting undervoltage release with switch (RUX)

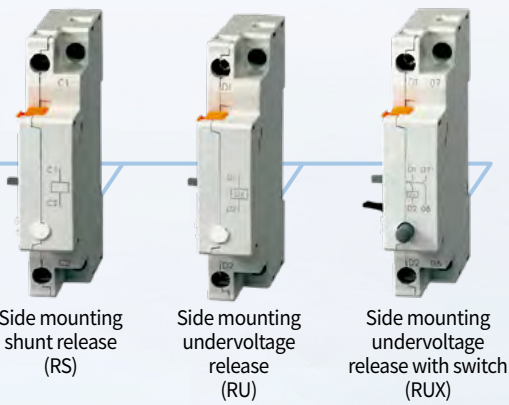

Side mounting shunt release (RS)

Side mounting undervoltage release (RU)

Side mounting undervoltage release with switch (RUX)

Direct adaptor  
Mini-MC



Mini-MC (9~16A)



Direct adaptor  
Metasol Susol-MC



Metasol : MC-6a~100a  
Susol : MC-9~95

Note)

1. Refer to page20 for installation of accessories.
2. LX, LA, and LAM are left attachment, RS, RU, and RUX are right attachment accessories.
3. Mini-MC and Metasol/Susol MC can be connected directly to MMS. (Refer to page 20 for details of DA connectors)
4. RUX : Not available with MMS-32S.

# Product Selection Guide



Terminal cover detachable type



Terminal cover detachable type

Frame		32AF																						
Type	Current adjustable type	MMS-32D				MMS-32S				MMS-32H														
	Instantaneous type	-				-				-														
Breaking capacity		-				Standard				High breaking														
Handle type		Button				Toggle				Rotary														
Number of poles		3				3				3														
Rated operational voltage (Ue)		AC 400/415V				Up to 690V				Up to 690V														
Rated frequency		50/60Hz				50/60 Hz				50/60 Hz														
Rated insulation voltage (Ui)		690V				690V				690V														
Rated impulse voltage (Uimp)		6kV				6kV				6kV														
Utilization category IEC 60 947-2 (Breaker)		Cat. A				Cat. A				Cat. A														
Utilization category IEC 60 947-4 (Motor starter)		AC 3				AC 3				AC 3														
Mechanical endurance (Operating)		100,000				100,000				100,000														
Electrical endurance (Cycles)		100,000				100,000				100,000														
Max operating frequency per hour (Ope./h)		25				25				25														
Temperature compensation (Operation)		-5 ~ +40°C				-20 ~ +60°C				-20 ~ +60°C														
Instantaneous short circuit release		14.4 × I <sub>e</sub> max.				13 × I <sub>e</sub> max.				13 × I <sub>e</sub> max.														
Overload protection		○				○				MMS-32H(○), MMS-32HI(x)														
Phase failure function		○				○				MMS-32H(○), MMS-32HI(x)														
Trip indicating function		×				×				○														
Test function		○				○				○														
Certification		CE, CCC				CE, CCC, UL, EAC, Marine, KC																		
Weight (g)		285				320				360														
Rated breaking capacity (kA)	Rated operational current (I <sub>e</sub> ) / (MMS-32D)	415V 400V		240V 230V 220V		415V 400V		460V 440V		525V 500V		690V 600V		240V 230V 220V		415V 400V		460V 440V		525V 500V		690V 600V		
	Thermal release adjustment range (I <sub>e</sub> ) / (MMS-32D)																							
		I <sub>cu</sub>	I <sub>cs</sub>	I <sub>cu</sub>	I <sub>cs</sub>	I <sub>cu</sub>	I <sub>cs</sub>	I <sub>cu</sub>	I <sub>cs</sub>	I <sub>cu</sub>	I <sub>cs</sub>	I <sub>cu</sub>	I <sub>cs</sub>	I <sub>cu</sub>	I <sub>cs</sub>	I <sub>cu</sub>	I <sub>cs</sub>	I <sub>cu</sub>	I <sub>cs</sub>	I <sub>cu</sub>	I <sub>cs</sub>	I <sub>cu</sub>	I <sub>cs</sub>	
	0.16	0.1~0.16	100	100	100	100	100	100	100	100	100	100	100	100	100	100	100	100	100	100	100	100	100	100
	0.25	0.16~0.25	100	100	100	100	100	100	100	100	100	100	100	100	100	100	100	100	100	100	100	100	100	100
	0.4	0.25~0.4	100	100	100	100	100	100	100	100	100	100	100	100	100	100	100	100	100	100	100	100	100	100
	0.63	0.4~0.63	100	100	100	100	100	100	100	100	100	100	100	100	100	100	100	100	100	100	100	100	100	100
	1	0.63~1	100	100	100	100	100	100	100	100	100	100	100	100	100	100	100	100	100	100	100	100	100	100
	1.6	1~1.6	100	100	100	100	100	100	100	100	100	100	3	3	100	100	100	100	100	100	100	100	100	100
	2.5	1.6~2.5	100	100	100	100	100	100	100	100	50	38	3	3	100	100	100	100	100	100	100	100	8	8
	4	2.5~4	100	100	100	100	100	100	50	38	15	11	3	3	100	100	100	100	100	100	100	100	8	8
	6/(6.3)	4~6/(4~6.3)	100	100	100	100	100	100	15	11	10	8	3	3	100	100	100	100	100	100	100	100	6	6
	8	5~8	-	-	100	100	100	100	15	11	10	8	3	3	100	100	100	100	50	38	50	38	6	6
	10	6~10	100	100	100	100	50	38	15	11	6	5	3	3	100	100	100	100	50	38	50	38	6	6
	13/(14)	9~13/(9~14)	15	7.5	100	100	50	38	10	8	6	5	3	3	100	100	100	100	50	38	42	32	6	6
	17/(18)	11~17/(13~18)	15	7.5	50	38	20	15	10	8	6	5	3	3	100	100	50	38	25	15	10	8	4	4
	22/(23)	14~22/(17~23)	15	6	40	30	15	11	8	6	6	5	3	3	100	100	50	38	25	15	10	8	4	4
26/(25)	18~26/(20~25)	15	6	40	30	15	11	8	6	5	4	3	3	100	100	50	38	25	15	10	8	4	4	
32	22~32/(24~32)	10	6	30	22	15	11	6	4	5	4	3	3	100	100	50	38	25	15	10	8	4	4	
40	28~40	-	-	20	15	10	8	5	3	4	3	2	2	100	100	40	30	15	11	8	6	3	3	
50	34~50	-	-	-	-	-	-	-	-	-	-	-	-	-	-	-	-	-	-	-	-	-	-	
63	45~63	-	-	-	-	-	-	-	-	-	-	-	-	-	-	-	-	-	-	-	-	-	-	
65	47~65	-	-	-	-	-	-	-	-	-	-	-	-	-	-	-	-	-	-	-	-	-	-	
75	55~75	-	-	-	-	-	-	-	-	-	-	-	-	-	-	-	-	-	-	-	-	-	-	
90	70~90	-	-	-	-	-	-	-	-	-	-	-	-	-	-	-	-	-	-	-	-	-	-	
100	80~100	-	-	-	-	-	-	-	-	-	-	-	-	-	-	-	-	-	-	-	-	-	-	

Note) Safety certification is obtained based on 220V and 460V.

Note) There is no current adjustment range for HI products. (Refer to page 14 for Model and Rating)



63AF		100AF	
MMS-63S	MMS-63H	MMS-100S	MMS-100H
-	MMS-63HI	-	MMS-100HI
Standard	High breaking	Standard	High breaking
Rotary	Rotary	Rotary	Rotary
3	3	3	3
Up to 690V	Up to 690V	Up to 690V	Up to 690V
50/60 Hz	50/60 Hz	50/60 Hz	50/60 Hz
1000V	1000V	1000V	1000V
8kV	8kV	8kV	8kV
Cat. A	Cat. A	Cat. A	Cat. A
AC 3	AC 3	AC 3	AC 3
50,000	50,000	50,000	50,000
25,000	25,000	25,000	25,000
25	25	25	25
-20 ~ +60°C	-20 ~ +60°C	-20 ~ +60°C	-20 ~ +60°C
13 × I <sub>e</sub> max.	13 × I <sub>e</sub> max	13 × I <sub>e</sub> max.	13 × I <sub>e</sub> max.
○	MMS-63H(○), MMS-63HI(×)	○	MMS-100H(○), MMS-100HI(×)
○	MMS-63H(○), MMS-63HI(×)	○	MMS-100H(○), MMS-100HI(×)
○	○	○	○
○	○	○	○

CE, CCC, UL, EAC, Marine, KC

1,000													2,200												
240V 230V 220V	415V 400V	460V 440V	252V 500V	690V 600V	240V 230V 220V	415V 400V	460V 440V	525V 500V	690V 600V	240V 230V 220V	415V 400V	460V 440V	525V 500V	690V 600V	240V 230V 220V	415V 400V	460V 440V	525V 500V	690V 600V						
Icu	Ics	Icu	Ics	Icu	Ics	Icu	Ics	Icu	Ics	Icu	Ics	Icu	Ics	Icu	Ics	Icu	Ics	Icu	Ics	Icu	Ics				
-	-	-	-	-	-	-	-	-	-	-	-	-	-	-	-	-	-	-	-	-	-				
-	-	-	-	-	-	-	-	-	-	-	-	-	-	-	-	-	-	-	-	-	-				
-	-	-	-	-	-	-	-	-	-	-	-	-	-	-	-	-	-	-	-	-	-				
-	-	-	-	-	-	-	-	-	-	-	-	-	-	-	-	-	-	-	-	-	-				
-	-	-	-	-	-	-	-	-	-	-	-	-	-	-	-	-	-	-	-	-	-				
-	-	-	-	-	-	-	-	-	-	-	-	-	-	-	-	-	-	-	-	-	-				
-	-	-	-	-	-	-	-	-	-	-	-	-	-	-	-	-	-	-	-	-	-				
-	-	-	-	-	-	-	-	-	-	-	-	-	-	-	-	-	-	-	-	-	-				
-	-	-	-	-	-	-	-	-	-	-	-	-	-	-	-	-	-	-	-	-	-				
-	-	-	-	-	-	-	-	-	-	-	-	-	-	-	-	-	-	-	-	-	-				
100	100	100	100	15	12	10	8	4	3	100	100	100	100	50	38	50	38	6	5	-	-				
100	100	50	38	10	8	6	5	4	3	100	100	100	100	50	38	42	32	6	5	-	-				
100	100	25	19	10	8	6	5	4	3	100	100	50	50	50	38	12	9	5	5	100	100				
50	38	25	19	10	8	6	5	4	3	100	100	50	50	50	38	12	9	5	5	100	100				
50	38	25	19	10	8	6	5	4	3	100	100	50	50	35	27	12	9	5	5	100	100				
50	38	25	19	10	8	6	5	4	3	100	100	50	50	35	27	10	8	5	5	100	100				
50	38	25	19	10	8	6	5	4	3	100	100	50	50	35	27	10	8	5	5	100	100				
50	38	25	19	10	8	6	5	4	3	100	100	50	50	35	27	10	8	5	5	100	100				
50	38	25	19	10	8	6	5	4	3	100	100	50	50	35	27	10	8	5	5	100	100				
50	38	25	19	10	8	6	5	4	3	75	50	35	27	25	19	6	5	3	3	-	-				
-	-	-	-	-	-	-	-	-	-	-	-	-	-	-	-	-	-	-	-	100	100				
-	-	-	-	-	-	-	-	-	-	-	-	-	-	-	-	-	-	-	-	100	100				
-	-	-	-	-	-	-	-	-	-	-	-	-	-	-	-	-	-	-	-	100	100				

# Model and Rating

## Standard type

- Adjustable thermal release
- Magnetic release 13 le max.
- Trip class 10
- Protective function
- Phase-failure protection
  - Phase-failure
  - Short circuit
  - Overload



Type	Rated operational current Ie [A]	Thermal release adjustment range [A]	Magnetic release operating current [A]	Switching of 3 phase AC motors, AC-2, AC-3						400/415V	
				3-phase [kW] (50/60Hz)			3-phase [HP] (60Hz)			Icu [kA]	Ics [kA]
				230V	400V	690V	230V	460V	575V		
MMS-32D	0.16	0.1~0.16	2.3	-	-	0.06	-	-	-	100	100
	0.25	0.16~0.25	3.6	-	0.06	0.12	-	-	-	100	100
	0.4	0.25~0.4	5.8	0.06	0.09	0.18	-	-	-	100	100
	0.63	0.4~0.63	9.1	0.09	0.18	0.25	-	-	-	100	100
	1	0.63~1	14.4	0.18	0.25	0.55	-	-	1/2	100	100
	1.6	1~1.6	23.0	0.25	0.55	1.1	-	3/4	3/4	100	100
	2.5	1.6~2.5	36.0	0.37	0.75	1.5	1/2	1	1.5	100	100
	4	2.5~4	57.6	0.75	1.5	3.0	3/4	2	3	100	100
	6.3	4~6.3	90.7	1.5	2.2	4.0	1.5	3	5	100	100
	10	6~10	144.0	2.2	4.0	7.5	3	5	7.5	100	100
	14	9~14	201.6	3.0	5.5	11	3	10	10	15	7.5
	18	13~18	259.2	4.0	7.5	15	5	10	15	15	7.5
	23	17~23	331.2	5.5	11	18.5	7.5	15	20	15	6
25	20~25	360.0	5.5	11	22	7.5	15	20	15	6	
32	24~32	460.8	7.5	15	30	10	20	25	10	6	
MMS-32S	0.16	0.1...0.16	2.1	-	0.02	-	-	-	-	100	100
	0.25	0.16...0.25	3.3	0.03	0.06	-	-	-	-	100	100
	0.4	0.25...0.4	5.2	0.06	0.09	-	-	-	-	100	100
	0.63	0.4...0.63	8.2	0.09	0.12	0.25	-	-	-	100	100
	1	0.63...1.0	13	0.12	0.25	0.55	-	1/2	1/2	100	100
	1.6	1.0...1.6	20.8	0.25	0.55	1.1	1/3	3/4	1	100	100
	2.5	1.6...2.5	32.5	0.37	0.75	1.5	1/2	1 1/2	1 1/2	100	100
	4	2.5...4.0	52	0.75	1.5	3	1	2	3	100	100
	6	4...6	78	1.5	2.2	4	1 1/2	5	5	100	100
	8	5...8	104	1.5	3	5.5	2	5	5	100	100
	10	6...10	130	3	4	7.5	3	7 1/2	10	50	38
	13	9...13	169	3	5.5	11	3	7 1/2	10	50	38
	17	11...17	221	4	7.5	11	5	10	15	20	15
	22	14...22	286	4	7.5	15	7 1/2	15	20	15	11
	26	18...26	338	5.5	11	18.5	7 1/2	15	20	15	11
32	22...32	416	7.5	15	22	10	20	30	15	11	
40	28~40	520	7.5	18.5	30	15	30	40	10	8	
MMS-63S	10	6~10	130	3	4	7.5	3	7 1/2	10	100	100
	13	9~13	169	3	5.5	11	3	7 1/2	10	50	38
	17	11~17	221	4	7.5	11	5	10	15	25	19
	22	14~22	286	4	7.5	15	7 1/2	15	20	25	19
	26	18~26	338	5.5	11	18.5	10	20	25	25	19
	32	22~32	416	7.5	15	22	10	25	30	25	19
	40	28~40	520	7.5	18.5	30	15	30	40	25	19
	50	34~50	650	11	22	45	15	40	50	25	19
	63	45~63	819	15	30	55	20	50	60	25	19
	65	47~65	845	15	30	55	20	50	60	25	19
MMS-100S	17	11~17	221	4	7.5	11	5	10	15	50	38
	22	14~22	286	4	7.5	15	7 1/2	15	20	50	38
	26	18~26	338	5.5	11	18.5	10	20	25	50	38
	32	22~32	416	7.5	15	22	10	25	30	50	38
	40	28~40	520	7.5	18.5	30	15	30	40	50	38
	50	34~50	650	11	22	45	15	40	50	50	38
	63	45~63	819	15	30	55	20	50	60	50	38
	75	55~75	975	22	37	63	25	60	75	50	38
90	70~90	1170	30	45	75	30	75	100	50	38	
100	80~100	1300	30	45	90	40	75	100	50	38	

## High breaking type

- Adjustable thermal release
- Magnetic release 13 le max.
- Trip class 10
- Protective function
- Phase-failure protection
  - Phase-failure
  - Short circuit
  - Overload

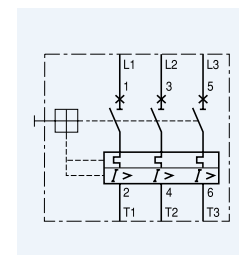

Circuit diagram

Type	Rated operational current I <sub>e</sub> [A]	Thermal release adjustment range [A]	Magnetic release operating current [A]	Switching of 3 phase AC motors, AC-2, AC-3						400/415V	
				3-phase [kW] (50/60Hz)			3-phase [HP] (60Hz)			I <sub>cu</sub> [kA]	I <sub>cs</sub> [kA]
				230V	400V	690V	230V	460V	575V		
MMS-32H	0.16	0.1...0.16	2.1	-	0.02	-	-	-	-	100	100
	0.25	0.16...0.25	3.3	0.03	0.06	-	-	-	-	100	100
	0.4	0.25...0.4	5.2	0.06	0.09	-	-	-	-	100	100
	0.63	0.4...0.63	8.2	0.09	0.12	0.25	-	-	-	100	100
	1	0.63...1.0	13	0.12	0.25	0.55	-	1/2	1/2	100	100
	1.6	1.0...1.6	20.8	0.25	0.55	1.1	1/3	3/4	1	100	100
	2.5	1.6...2.5	32.5	0.37	0.75	1.5	1/2	1½	1½	100	100
	4	2.5...4.0	52	0.75	1.5	3	1	2	3	100	100
	6	4...6	78	1.5	2.2	4	1½	5	5	100	100
	8	5...8	104	1.5	3	5.5	2	5	5	100	100
	10	6...10	130	3	4	7.5	3	7½	10	100	100
	13	9...13	169	3	5.5	11	3	7½	10	100	100
	17	11...17	221	4	7.5	11	5	10	15	50	38
	22	14...22	286	4	7.5	15	7½	15	20	50	38
	26	18...26	338	5.5	11	18.5	7½	15	20	50	38
32	22...32	416	7.5	15	22	10	20	30	50	38	
40	28-40	520	7.5	18.5	30	15	30	40	40	30	
MMS-63H	10	6~10	130	3	4	7.5	3	7½	10	100	100
	13	9~13	169	3	5.5	11	3	7½	10	100	100
	17	11~17	221	4	7.5	11	5	10	15	50	50
	22	14~22	286	4	7.5	15	7½	15	20	50	50
	26	18~26	338	5.5	11	18.5	10	20	25	50	50
	32	22~32	416	7.5	15	22	10	25	30	50	50
	40	28-40	520	7.5	18.5	30	15	30	40	50	50
	50	34-50	650	11	22	45	15	40	50	50	50
	63	45~63	819	15	30	55	20	50	60	50	50
65	47~65	845	15	30	55	20	50	60	35	27	
MMS-100	17	11~17	221	4	7.5	11	5	10	15	100	100
	22	14~22	286	4	7.5	15	7½	15	20	100	50
	26	18~26	338	5.5	11	18.5	10	20	25	100	50
	32	22~32	416	7.5	15	22	10	25	30	100	50
	40	28~40	520	7.5	18.5	30	15	30	40	100	50
	50	34-50	650	11	22	45	15	40	50	100	50
	63	45~63	819	15	30	55	20	50	60	100	50
	75	55~75	975	22	37	63	25	60	75	75	50
90	70~90	1170	30	45	75	30	75	100	75	50	
100	80~100	1300	30	45	90	40	75	100	75	50	

# Model and Rating

## Instantaneous type

- Without thermal releases
- Magnetic release 13 le max.
- Protective function
  - Short circuit



Type	Rated operational current I <sub>e</sub> [A]	Thermal release adjustment range [A]	Magnetic release operating current [A]	Switching of 3 phase AC motors, AC-2, AC-3						400/415V	
				3-phase [kW] (50/60Hz)			3-phase [HP] (60Hz)			I <sub>cu</sub> [kA]	I <sub>cs</sub> [kA]
				230V	400V	690V	230V	460V	575V		
MMS-32HI	0.16	-	2.1	-	0.02	-	-	-	-	100	100
	0.25	-	3.3	0.03	0.06	-	-	-	-	100	100
	0.4	-	5.2	0.06	0.09	-	-	-	-	100	100
	0.63	-	8.2	0.09	0.12	0.25	-	-	-	100	100
	1	-	13	0.12	0.25	0.55	-	1/2	1/2	100	100
	1.6	-	20.8	0.25	0.55	1.1	1/3	3/4	1	100	100
	2.5	-	32.5	0.37	0.75	1.5	1/2	1½	1½	100	100
	4	-	52	0.75	1.5	3	1	2	3	100	100
	6	-	78	1.5	2.2	4	1½	5	5	100	100
	8	-	104	1.5	3	5.5	2	5	5	100	100
	10	-	130	3	4	7.5	3	7½	10	100	100
	13	-	169	3	5.5	11	3	7½	10	100	100
	17	-	221	4	7.5	11	5	10	15	50	38
	22	-	286	4	7.5	15	7½	15	20	50	38
	26	-	338	5.5	11	18.5	7½	15	20	50	38
	32	-	416	7.5	15	22	10	20	30	50	38
MMS-63HI	10	-	130	3	4	7.5	3	7½	10	100	100
	13	-	169	3	5.5	11	3	7½	10	100	100
	17	-	221	4	7.5	11	5	10	15	50	50
	22	-	286	4	7.5	15	7½	15	20	50	50
	26	-	338	5.5	11	18.5	10	20	25	50	50
	32	-	416	7.5	15	22	10	25	30	50	50
	40	-	520	7.5	18.5	30	15	30	40	50	50
	50	-	650	11	22	45	15	40	50	50	50
	63	-	819	15	30	55	20	50	60	50	50
	65	-	845	15	30	55	20	50	60	35	27
MMS-100HI	17	-	221	4	7.5	11	5	10	15	100	100
	22	-	286	4	7.5	15	7½	15	20	100	50
	26	-	338	5.5	11	18.5	10	20	25	100	50
	32	-	416	7.5	15	22	10	25	30	100	50
	40	-	520	7.5	18.5	30	15	30	40	100	50
	50	-	650	11	22	45	15	40	50	100	50
	63	-	819	15	30	55	20	50	60	100	50
	75	-	975	22	37	63	25	60	75	75	50
	90	-	1170	30	45	75	30	75	100	75	50
	100	-	1300	30	45	90	40	75	100	75	50

## Auxiliary contact

### FX Auxiliary switch

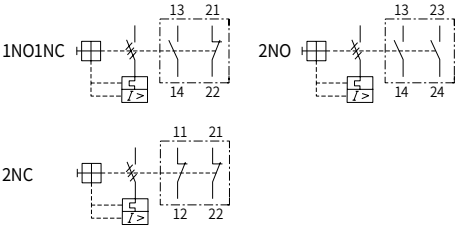
Picture	Description	Connection diagram
	<ul style="list-style-type: none"> <li>• Front mounting</li> <li>• 2-pole</li> <li>• One front mounting module per circuit breaker</li> </ul>	

### LX Auxiliary switch

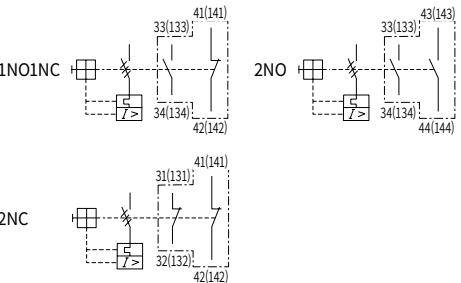
Picture	Description	Connection diagram
	<ul style="list-style-type: none"> <li>• Side mounting on the left</li> <li>• 2-pole</li> <li>• One side mounting module per circuit breaker</li> </ul>	

## Alarm contact

### LA Any trip alarm switch 32FA, 63/100AF

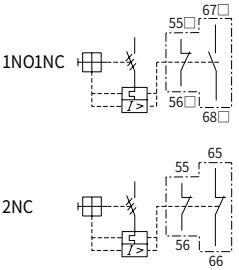
Picture	Description	Connection diagram
	<ul style="list-style-type: none"> <li>• Operates in case of trip</li> <li>• Side mounting on the left</li> <li>• 2-pole</li> <li>• Set LA first in case of using LX together (MMS-63 can not accept LX and LA together)</li> </ul>	

### LAM Magnetic trip alarm switch

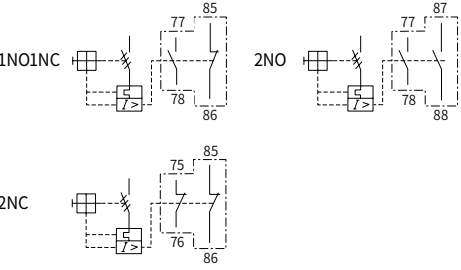
Picture	Description	Connection diagram
	<ul style="list-style-type: none"> <li>• Short circuit trip only action</li> <li>• Side mounting on the left</li> <li>• 2-pole</li> <li>• Set LAM first in case of using LX together</li> </ul>	

# Accessories

## Trip device

### RS Shunt release

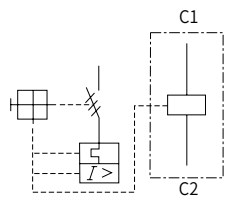
Picture	Rated voltage	Description	Connection diagram
	<ul style="list-style-type: none"> <li>• 24V 50Hz / 28V 60Hz</li> <li>• 110 50Hz / 120V 60Hz</li> <li>• 220~230V 50Hz / 240~260V 60Hz</li> <li>• 240V 50Hz / 277V 60Hz</li> <li>• 380~400V 50Hz / 440~460V 60Hz</li> <li>• 415~440V 50Hz / 460~480V 60Hz</li> </ul>	<ul style="list-style-type: none"> <li>• Side mounting on the right</li> <li>• One side mounting module per circuit breaker.</li> <li>• Can not use with RU or RUX</li> </ul>	

### RU Undervoltage release

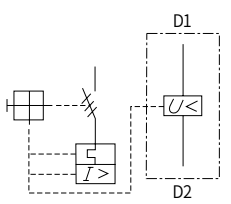
Picture	Rated voltage	Description	Connection diagram
	<ul style="list-style-type: none"> <li>• 24V 50Hz / 28V 60Hz</li> <li>• 110 50Hz / 120V 60Hz</li> <li>• 220~230V 50Hz / 240~260V 60Hz</li> <li>• 240V 50Hz / 277V 60Hz</li> <li>• 380~400V 50Hz / 440~460V 60Hz</li> <li>• 415~440V 50Hz / 460~480V 60Hz</li> </ul>	<ul style="list-style-type: none"> <li>• Side mounting on the right</li> <li>• One side mounting module per circuit breaker.</li> <li>• Can not use with RU or RUX</li> </ul>	

### RUX Undervoltage release with switch

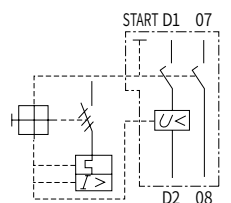
Picture	Rated voltage	Description	Connection diagram
	<ul style="list-style-type: none"> <li>• 24V 50Hz / 28V 60Hz</li> <li>• 110 50Hz / 120V 60Hz</li> <li>• 220~230V 50Hz / 240~260V 60Hz</li> <li>• 240V 50Hz / 277V 60Hz</li> <li>• 380~400V 50Hz / 440~460V 60Hz</li> <li>• 415~440V 50Hz / 460~480V 60Hz</li> </ul>	<ul style="list-style-type: none"> <li>• Side mounting on the right</li> <li>• One side mounting module per circuit breaker.</li> <li>• Can not use with RU or RUX</li> <li>• Can not attach to MMS-32S</li> </ul>	



## Auxiliaries

Contents			Auxiliary contacts for front mounting FX		Auxiliary contacts for front mounting LX		Alarm switch for left side mounting LA		
Rated thermal current / th									
at 40°C ambient temperature			[A]	5	10		10		
at 60°C ambient temperature			[A]	3	6		6		
Contact class coordination									
according to NEMA			AC	A 300	A 600		A 600		
(UL/CSA-standards)			DC	R 300	Q 300		Q 300		
Back-up fuses gG, gL			[A]	16	16		16		
Rated supply current			[V]	-	24	240	24	240	
AC-15			[A]	-	6	4	6	4	
DC-13			[V]	24	220	24	220	24	
			[A]	1	0.1	2	0.25	2	
Weight (g)			18		30		40		
Terminal parts									
Wire									
Single-core			1 conductor	[mm <sup>2</sup> ] / [AWG]	0.5...2.5 / 20...14		0.5...2.5 / 20...14		
			2 conductor	[mm <sup>2</sup> ] / [AWG]	-		0.5...2.5 / 20...14		
Stranded			1 conductor	[mm <sup>2</sup> ] / [AWG]	0.5...4 / 20...10		0.5...4 / 20...10		
			2 conductor	[mm <sup>2</sup> ] / [AWG]	0.75...2.5 / 18...14		0.75...2.5 / 18...14		
Tightening torque			[Nm] / [lb-in]	0.8...1.2 / 7...10		0.8...1.2 / 7...10		0.8...1.2 / 7...10	



Pozidriv size 2

0.5...2.5 / 20...14

0.5...2.5 / 20...14

0.5...4 / 20...10

0.75...2.5 / 18...14

0.8...1.2 / 7...10

Contents			Shunt release for right side mounting RS		Undervoltage release for right side mounting RU		Undervoltage release with 2 auxiliary contacts for right side mounting RUX		
Actuating voltage(V)									
Pull-in			0.85...1.1×Us		0.7...1.1×Us		0.85...1.1×Us		
Drop-out			0.7...0.35×Us				0.7...0.35×Us		
Rated control voltage(V)									
min.:			24V 50Hz / 28V 60Hz		24V 50Hz / 28V 60Hz		24V 50Hz / 28V 60Hz		
max.:			415~440V 50Hz / 460~480V 60Hz		415~440V 50Hz / 460~480V 60Hz		415~440V 50Hz / 460~480V 60Hz		
Coil rating(W)									
Pull-in			8.5VA, 6W		8.5VA, 6W		8.5VA, 6W		
Hold			3VA, 1.2W		3VA, 1.2W		3VA, 1.2W		
Opening time (ms)			20		-		20		
Weight (g)			120		110		110		
Terminal parts									
Wire									
Single-core			1 conductor	[mm <sup>2</sup> ] / [AWG]	0.5...2.5 / 20...14		0.5...2.5 / 20...14		
			2 conductor	[mm <sup>2</sup> ] / [AWG]	0.5...2.5 / 20...14		0.5...2.5 / 20...14		
Stranded			1 conductor	[mm <sup>2</sup> ] / [AWG]	0.5...4 / 20...10		0.5...4 / 20...10		
			2 conductor	[mm <sup>2</sup> ] / [AWG]	0.75...2.5 / 18...14		0.75...2.5 / 18...14		
Tightening torque			[Nm] / [lb-in]	0.8...1.2 / 7...10		0.8...1.2 / 7...10		0.8...1.2 / 7...10	

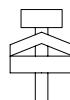

Pozidriv size 2

0.5...2.5 / 20...14

0.5...2.5 / 20...14

0.5...4 / 20...10



0.75...2.5 / 18...14

0.8...1.2 / 7...10

# Accessories(MMS-32D)

## Auxiliary contact

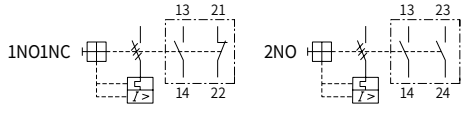
### Auxiliary switch

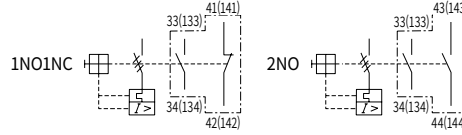
Picture	Model	Description	Connection diagram
	FXN-11	<ul style="list-style-type: none"> <li>• Front mounting</li> <li>• Only 1 unit can be installed</li> </ul>	
	FXN-20		
	LXN-11	<ul style="list-style-type: none"> <li>• Side mounting on the left</li> <li>• 2 each of LXN can be installed together</li> </ul>	
	LXN-20		

### Magnetic trip alarm switch

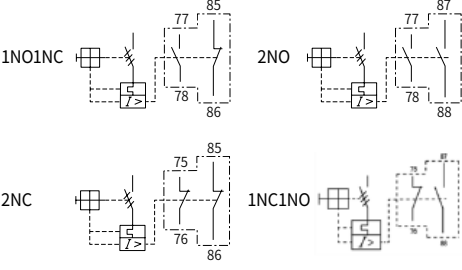
Picture	Model	Description	Connection diagram
	LAMN-1001	<ul style="list-style-type: none"> <li>• Side mounting on the left</li> <li>• Only 1 unit can be installed</li> </ul>	
	LAMN-1010		
	LAMN-0101		
	LAMN-0110		

## Shunt release

### Shunt release

Picture	Model	Rated voltage	Description
	RSN110	110~127V 50/60Hz	<ul style="list-style-type: none"> <li>• Side mounting on the right</li> <li>• Either one shunt or undervoltage release can be installed.</li> </ul>
	RSN220	220~240V 50/60Hz	
	RSN380	380~415V 50/60Hz	

## Undervoltage release

### Undervoltage release

Picture	Model	Rated voltage	Description
	RUN110	110~127V 50/60Hz	<ul style="list-style-type: none"> <li>• Side mounting on the right</li> <li>• Either one shunt or undervoltage release can be installed.</li> </ul>
	RUN220	220~240V 50/60Hz	
	RUN380	380~415V 50/60Hz	

## Installation of accessories

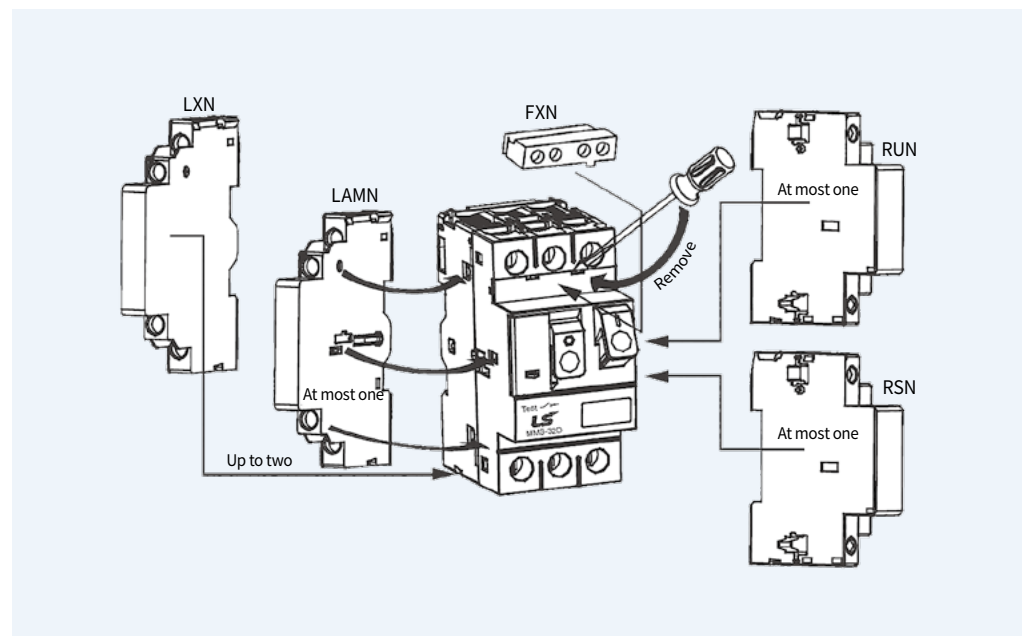

# Accessories

## Electrical auxiliaries

### E-handle (Rotary-type)



MMS E-Handle is a Rotary-type Handle accessory which can be attached to the front to control and verify the ON, TRIP, OFF condition of Manual Motor Starters under the situation of closing panel.

- Application model : MMS-32H/Hi, 63S/H/Hi, 100S/H/Hi
- Operation temp : -20 ~ +60°C
- CE and UL certified
- Degree of protection : IP65(UL Type1, Type3R)
- Locking device : Lockable in on/off position
- Material of insulation : Plastic(PA66)

Type	Application MMS	Remarks
MEH-32	MMS-32H, 32HI	Length of shaft : 115 or 315mm
MEH-63	MMS-63S, 63H, 63HI	
MEH-100	MMS-100S, 100H, 100HI	

### Phase bus system



It is a device for a parallel connection with power terminals in the circuit lined up by MMS, and it can provides the solution “Simple wiring” and “Compact wiring space”.

- Application model : MMS-32, 63
- Safety cover built-in
- CE and UL certified
- RoHS compliance

Type	Application MMS	Number of terminals	Rated current	Safety cover attached
PB-322	MMS-32S, 32H, 32HI	2 (MMS 2)	63A	PBPC-32
PBL-322	MMS-32S, 32H, 32HI with Aux (LX or LA or LAM)	2 (MMS 2)		
PB-323	MMS-32S, 32H, 32HI	3 (MMS 3)		
PBL-323	MMS-32S, 32H, 32HI with Aux (LX or LA or LAM)	3 (MMS 3)		
PB-324	MMS-32S, 32H, 32HI	4 (MMS 4)	108A	PBPC-63
PB-325	MMS-32S, 32H, 32HI	5 (MMS 5)		
PB-632	MMS-63S, 63H, 63HI	2 (MMS 2)		
PB-633	MMS-63S, 63H, 63HI	3 (MMS 3)		

### Line terminal block



Luge type is installed for simple wiring and convenience.

Model	LTB-32
Pole	3P
Mounting location	Upstream
IP degree of protection	IP20 according to IEC 60529
Rated insulation voltage (Ui)	690V according to IEC 60947-1
Rated operational current (Ie)	63A
Terminal torque	1.7 N.m- on screw clamp terminals

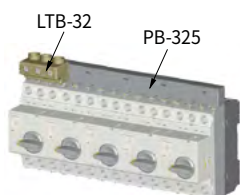

### Diagram

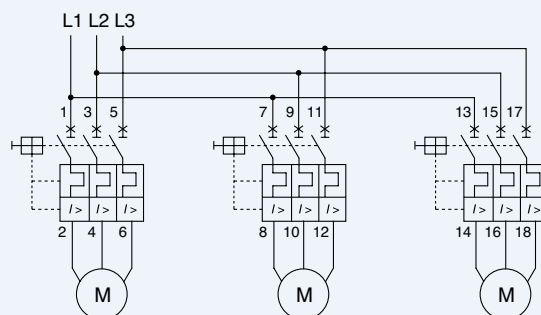

**Terminal block (TB-32)**



It is an accessory device for ensuring the insulation distance between phases. When this device is used, it meets the requirements of UL Combination Motor Controller Type E.

- Application model : MMS-32H, MMS-32HI

**Enclosure**



Case cover of MMS enclosure is specifically designed with dust-proof and corrosive-proof structure. Therefore, it is the optimum product to use in dusty areas such as cement plants, cotton mills as well as in the presence of corrosive gas or liquid (excl. explosive, flammable gas) such as fertilizer, refinery, and plating plant.

- Application Model : MMS-32
- Operation temp : -20 ~ +60°C
- Degree of protection : IP65
- Material of insulation : Plastic(ABS)
- CE and UL certified

Type	Application MMS	Remarks
EPH-32	MMS-32H, 32HI	Surface mount

**Dial cover**

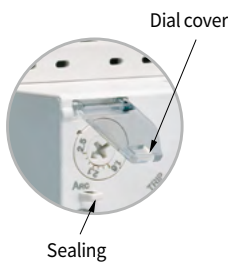

Dial cover is used to protect the set value from the operation that is not intended.

- Application Model : MMS-32, 63,100 (All types)

**Insulation barrier**



Insulation barrier is used to enlarge the creepage distance and clearance to meet the requirement of UL.

- Application Model : MMS-100

Type	Application MMS
IB100	MMS-100S, 100H, 100HI

**Screw mounting holder**

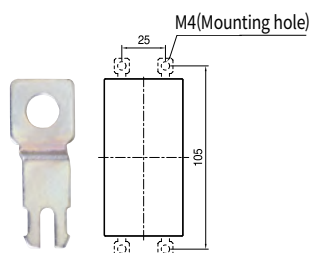

32AF MMS is only for DIN rail mountable by itself. Screw mounting holder is used to mount MMS on a panel by screws.

- Application Model : MMS-32

Type	Application MMS	Remarks
MP-32	MMS-32S, 32H, 32HI	For M4 screw

## Electrical auxiliaries

### Direct adaptor and mounting unit

Direct adaptor only

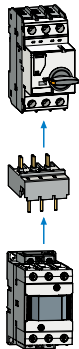

Direct adaptor + Mounting Unit (Option)

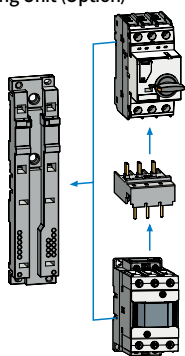

### Direct adaptor , DA

Direct adaptor is used to connect MMS directly with a contactor.

### Mounting unit , MU

This device is attached module to connect joined MMS with a contactor

• Application Model : MMS+Susol MC (MC-9~95), Mini MC

Direct adaptor		Mounting unit	Combined devices	Applying contactor	
Frame	Name				
DA-16	DA-16SA	MU-45	MMS-32S + GMC-6M~16M	Mini-MC	
	DA-16SD		MMS-32S + GMD-6M~16		
	DA-16HA		MMS-32H + GMC-6M~16M		
	DA-16HD		MMS-32H + GMD-6M~16M		
DA-18	DA-18SA		MMS-32S + MC-6a~18a	Metasol MC	
	DA-18SD		MMS-32S + MC-6a~18a DC		
	DA-18HA		MMS-32H + MC-6a~18a		
	DA-18HD		MMS-32H + MC-6a~18a DC		
DA-22	DA-22SA		MMS-32S + MC-9b~22b		Susol, Metasol MC
	DA-22SD		MMS-32S + MC-9b~22b DC		
	DA-22HA		MMS-32H + MC-9b~22b		
	DA-22HD		MMS-32H + MC-9b~22b DC		
DA-32	DA-32SA		MMS-32S + MC-9~32(32a, 40a)	Susol, Metasol MC	
	DA-32SD		MMS-32S + MC-9~32(32a, 40a) DC		
	DA-32HA		MMS-32H + MC-9~32(32a, 40a)		
	DA-32HD		MMS-32H + MC-9~32(32a, 40a) DC		
DA-63	DA-63A	MU-55	MMS-63AF + MC-35~63 (50a, 65a)	Susol, Metasol MC (Lug type only)	
	DA-63D		MMS-63AF + MC-35~63 (50a, 65a) DC		
DA-95A	DA-95A	MU-70	MMS-100AF + MC-65~95 (75a, 85a, 100a)	Susol, Metasol MC (Lug type only)	
	DA-95D		MMS-100AF + MC-65~95 (75a, 85a, 100a) DC		

## Possible combination chart

Please read this chart completely before installing the auxiliaries.

Improper combination can cause electric failure or accident.

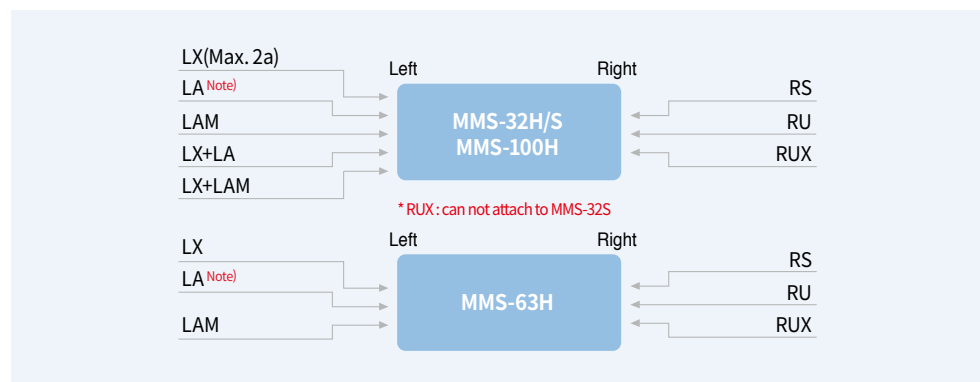

Note) LA(32 on 63/100 is a separate).

## Installation and use environment

### Terminals

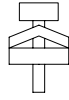
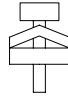
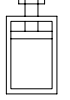
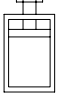
Contents		MMS-32S	MMS-32H	MMS-63S, 63H	MMS-100S, 100H
Conformity to standards		IEC60947-2, IEC60947-4-1 UL508, UL508 Type E (except MMS-32S)			
Approvals		CE, UL			
Terminal parts					
Wire					
Single-core	1 conductor	[mm <sup>2</sup> ] / [AWG] 1...10 / 18...8	1...10 / 18...8	0.75...35 / 18...2	2.5...70 / 12...2/0
	2 conductor	[mm <sup>2</sup> ] / [AWG] 1...6 / 18...10	1...6 / 18...10	0.75...25 / 18...4	2.5...50 / 12...1/0
Stranded	1 conductor	[mm <sup>2</sup> ] / [AWG] 1...6 / 18...10	1...6 / 18...10	0.75...35 / 18...2	2.5...70 / 12...2/0
	2 conductor	[mm <sup>2</sup> ] / [AWG] 1...6 / 18...10	1...6 / 18...10	0.75...25 / 18...4	2.5...50 / 12...1/0
Flexible	1 conductor	[mm <sup>2</sup> ] / [AWG] 1...6 / 18...10	1...6 / 18...10	0.75...25 / 18...4	2.5...50 / 12...1/0
	2 conductor	[mm <sup>2</sup> ] / [AWG] 0.75...4 / 18...10	0.75...4 / 18...10	0.75...16 / 18...6	2.5...35 / 10...2
Tightening torque		[Nm] / [lb-in] 0.8...2 / 7...22	0.8...2 / 7...22	3...4 / 26...39	4...6 / 35...53

### Power consumption

Contents	MMS-32S	MMS-32H	MMS-63S, 63H	MMS-100S, 100H
Total power loss pv circuit breaker at rated load operating temperature [W]	In = 0.16~1.6A : 4.4 In = 2.5~26A : 7.4 In = 32A : 4.0 In = 40A : 7.4	In = 0.16~1.6A : 4.4 In = 2.5~26A : 7.4 In = 32A : 4.0 In = 40A : 7.4	In = 10~22A : 10.2 In = 26~65A : 9.7	In = 17~32A : 15 In = 40~63A : 21.8 In = 75~100A : 17.8

### Installation and use method

#### Mounting

- 35mm DIN rail for MMS32~63
- 35mm or 75mm DIN rail for MMS100
- Use 15mm depth for 35mm DIN rail

#### Environment

- Ambient air temperature
  - Storage : - 50 ~ 80°C
  - Operation : - 20 ~ 60°C
- Ambient temperature compensation : - 5 ~ +40 °C
- Maximum operating altitude : 2000m
- Protection degree : IP20
- Shock resistance : 25g
- Vibration resistance : 5~150Hz

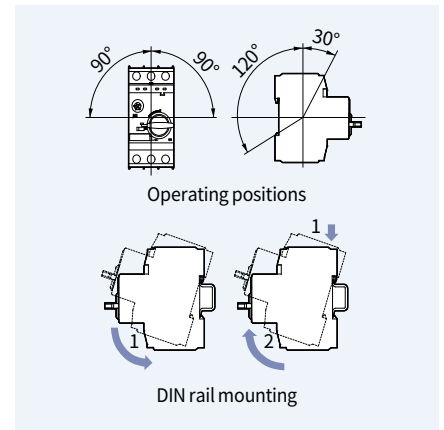

#### Caution for thermal adjustments

1. Keep the setting range as shown below.
2. Moving counterclockwise out of the setting range may cause the damage of the device.
3. Calibration by ambient air temperature

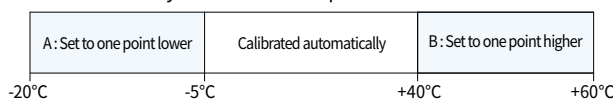

\* In case of using out of the standard air temperature range(-5°C~+40°C) it needs to be calibrated by one point

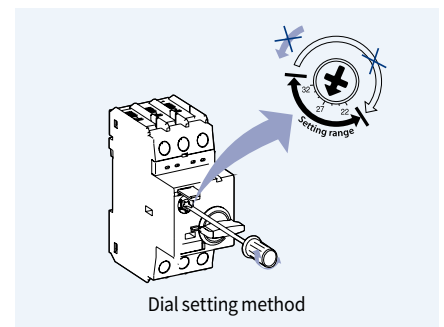

## Installation of auxiliaries

### MMS-32S/H/HI

Note) Refer to page 17 for MMS-32D Installation of auxiliaries.

Be sure to turn off the main switch of MMS before any other action.

- To install FX remove the cover ❶ first.
- 2 each of LX can be installed together.
- Only one of auxiliaries among RU, RS and RUX can be mounted on the right side of MMS.
- Do not give trip signal to RS longer than 10 sec.
- Refer to the possible combination chart for the mounting of LX, LA and LAM on left side of MMS.
- Push the trip button before installation of LAM
- Do not operate the alarm contact point (LA) when the operation switch is in the trip position.
- Remove the indicated part in the fig. before the additional installation of LX
- Be sure to turn off the main switch of MMS before the separation.
- Push softly the separation button on the side of the auxiliary and pull it.

• Please make sure to choose proper LA before use because LA for MMS-32 and MMS-63/100 is different.

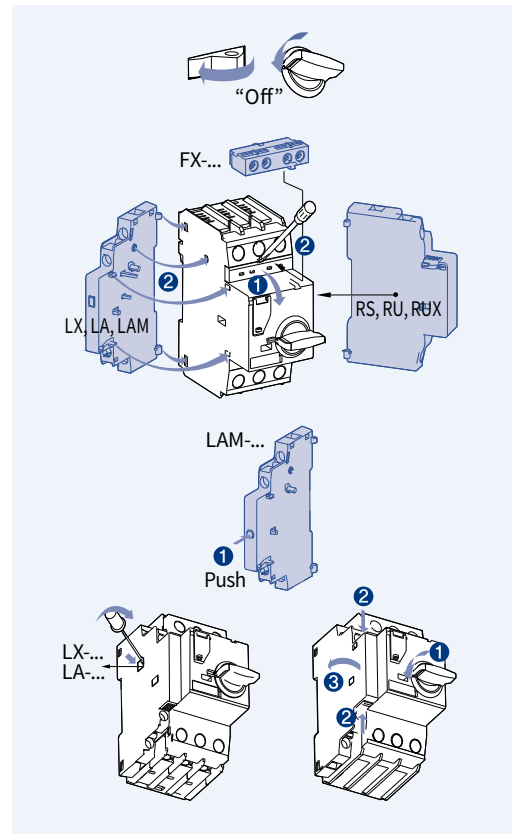

### MMS-63, 100S/H/HI

- To install FX remove the cover ❶ first.
- 2 each of LX can be installed together. (only 1 each for MMS-63)
- Only one of auxiliaries among RU, RS and RUX can be mounted on the right side of MMS.
- Do not give trip signal to RS longer than 10 sec.
- Refer to the possible combination chart for the mounting of LX, LA and LAM on left side of MMS.
- Do not use with LA-... (32) It is only for MMS-32.
- Push the trip button before installation of LAM
- Do not install LA in the status of TRIP of MMS-100
- Remove the indicated part as shown in the above fig. before the additional installation of LX
- Be sure to turn off the main switch of MMS before the separation.
- Push softly the separation button on the side of the auxiliary and pull it.

• Please make sure to choose proper LA before use because LA for MMS-32 and MMS-63/100 is different.

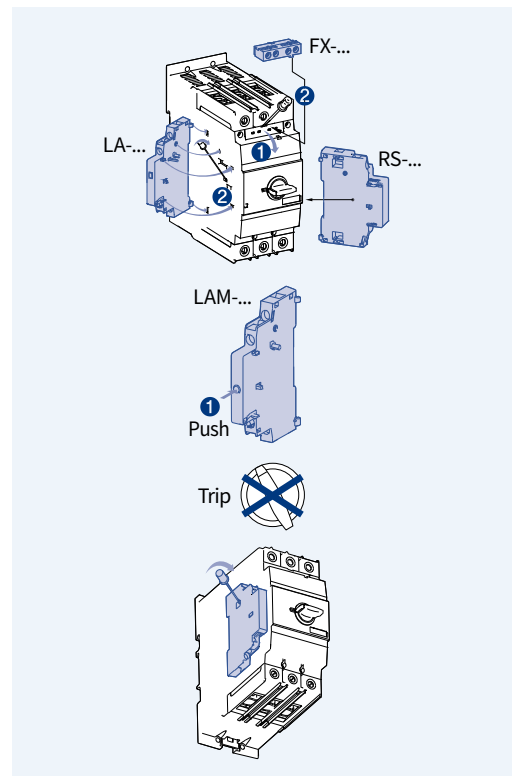



**How to Install and reset RUX**

**Installing**

- (1) Check if the trip button of RUX is "UP" . If not, push the side lever ❶ to come it up.
- (2) Fit the both lower hooks ❷ into the MMS.
- (3) Rotate the handle of MMS to the 20 to 30 degree ❸ to on direction and keep it.
- (4) Fit the both upper hooks ❹ into the MMS.
- (5) Input power to the RUX.
- (6) Turn on the handle of MMS.

**Resetting**

The trip button of RUX does not come "UP" in the event of tripping due to undervoltage.

To turn on the MMS after the tripping ❶ turn off the MMS and check if the trip button of RUX comes "UP" .

- ❷ push the trip button ❸ turn on the MMS

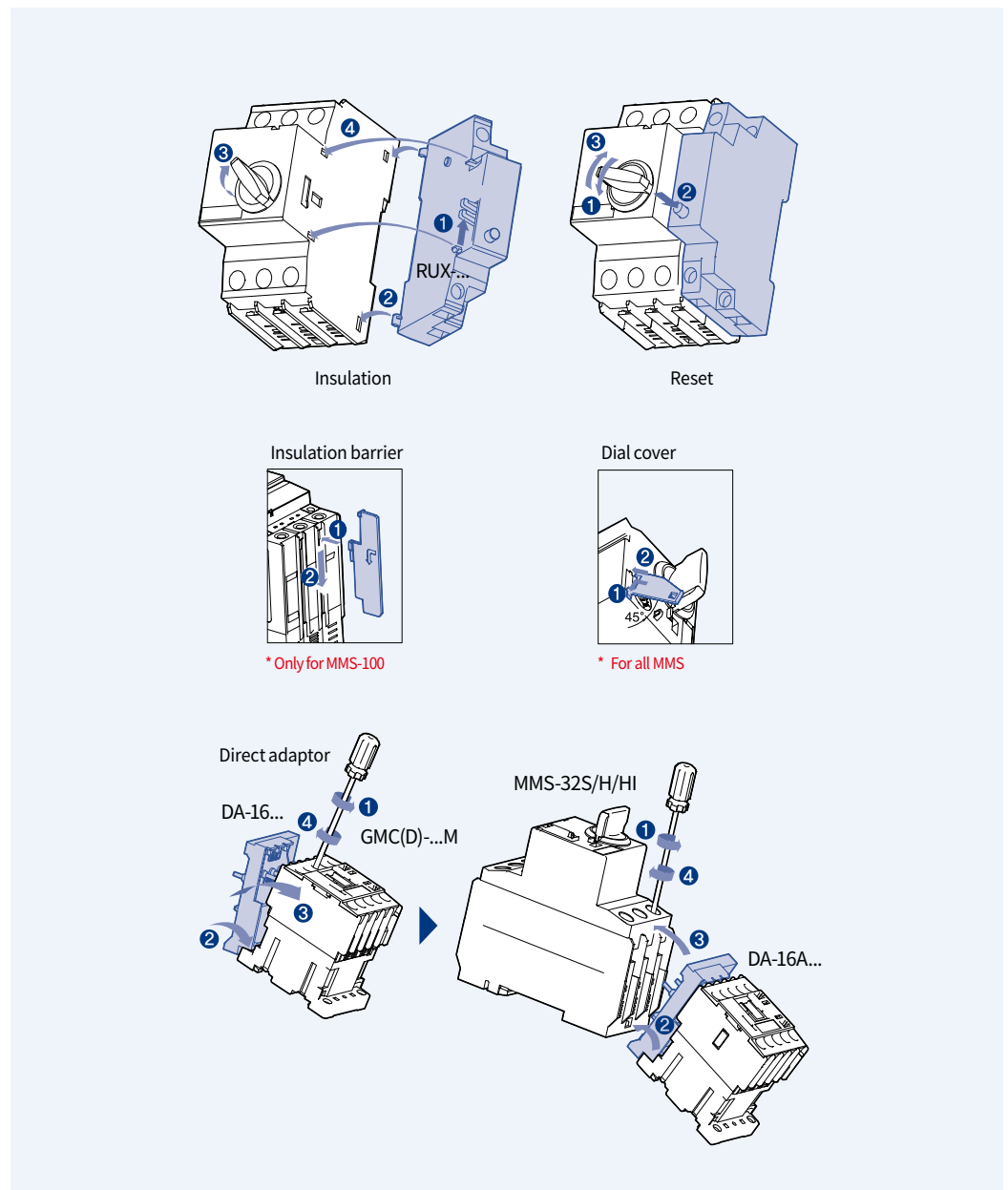

# Technical Information

## Installation of auxiliaries

### E-handle structure

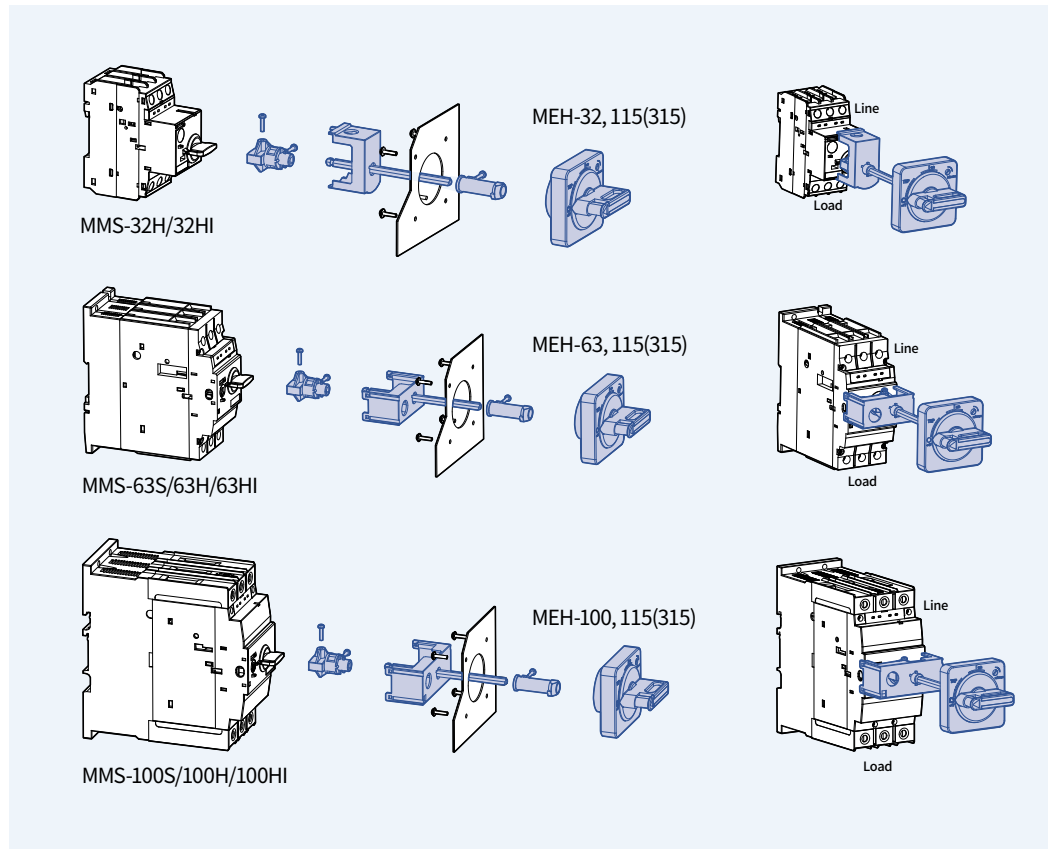

### E-handle locking device

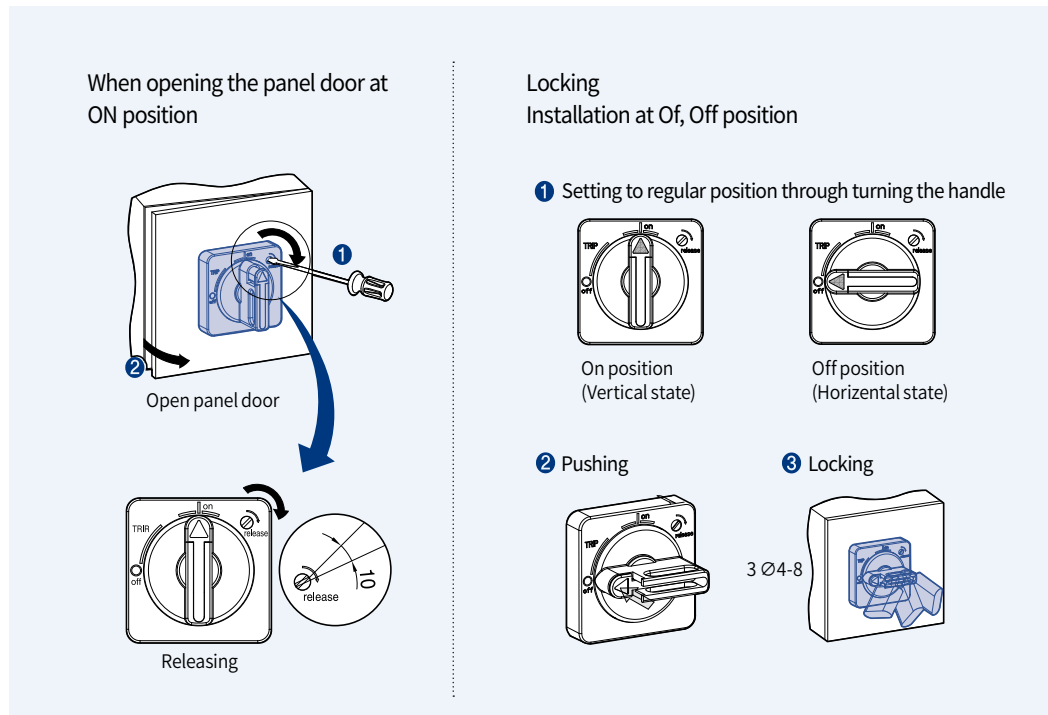

E-handle Installation

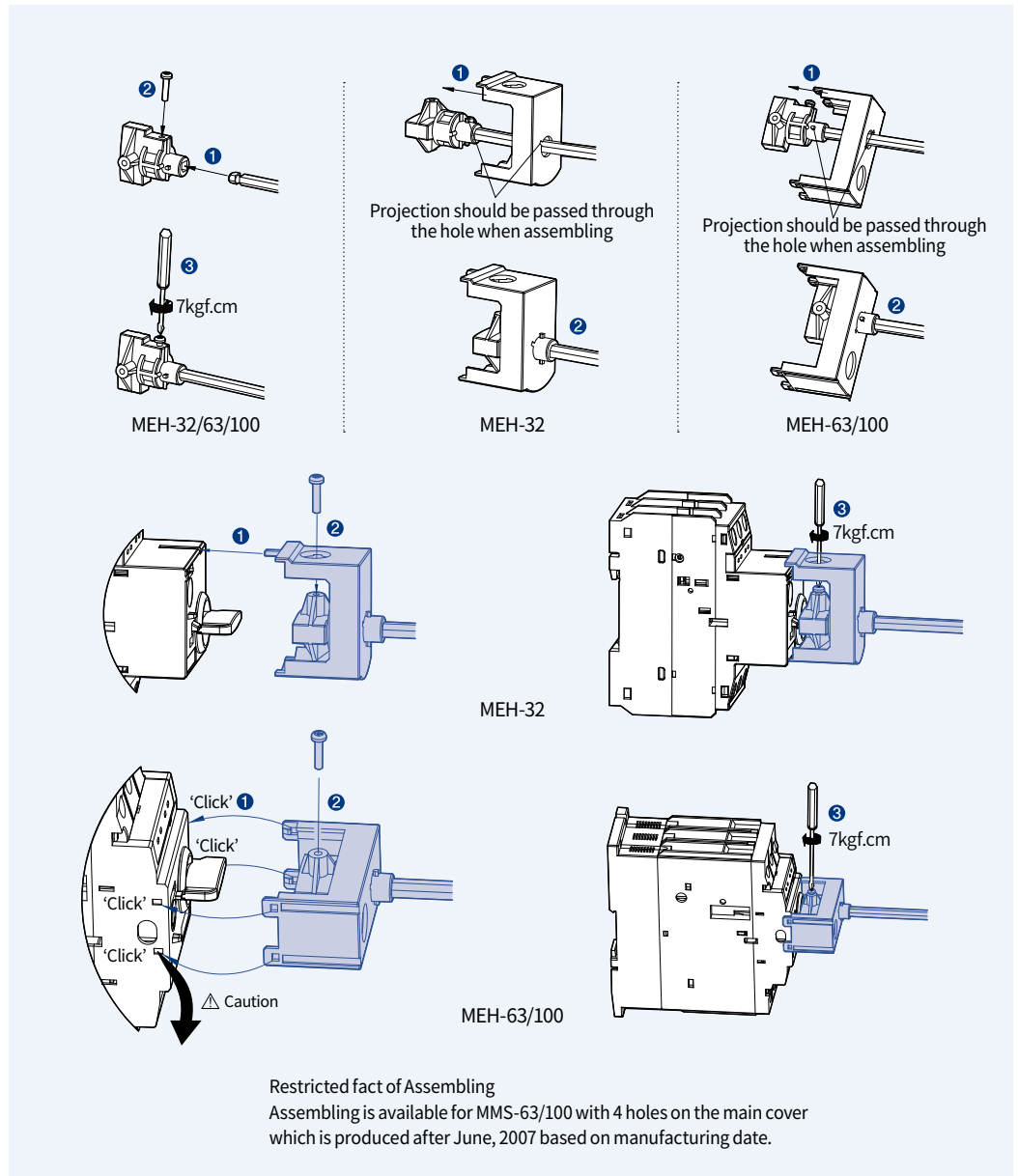

E-handle operating test

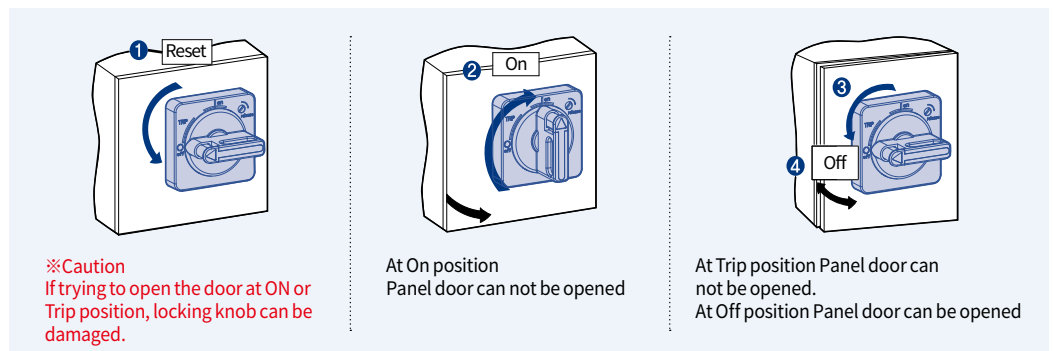

# Technical Information

## Installation of auxiliaries

[mm]

E-handle  
cutting off the shaft &  
applying the handle

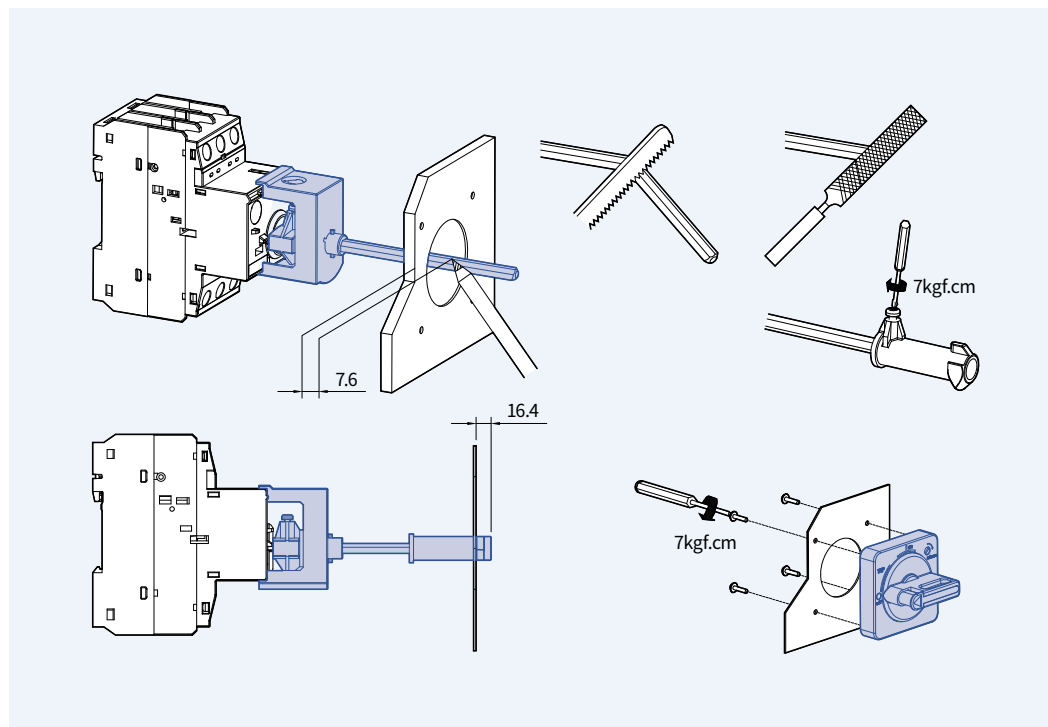

Enclosure

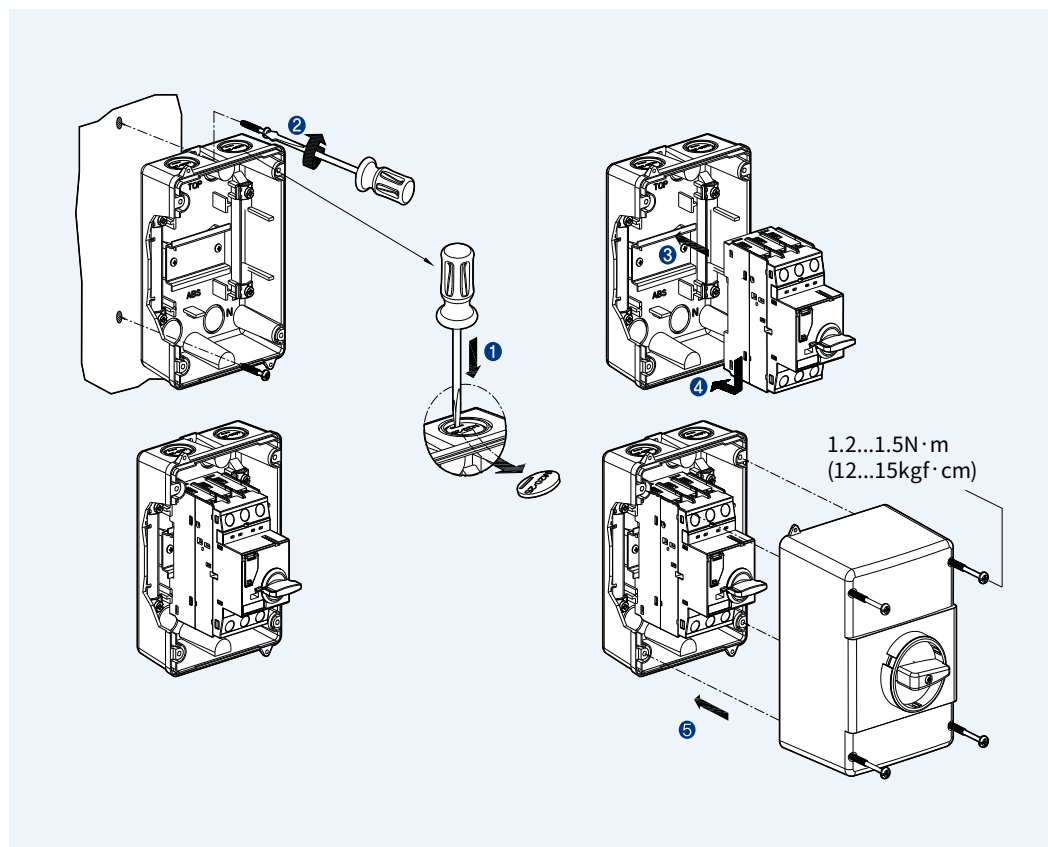

## IEC performance data (Motor protection)

### Standard type MMS-32S

Rated operational current Ie	0.16	0.25	0.4	0.63	1	1.6	2.5	4	6	8	10	13	17	22	26	32	40
Switching of standard three-phase motors AC-2, AC-3																	
230/240V [kW]	-	0.03	0.06	0.09	0.12	0.18/0.25	0.37	0.55/0.75	1.1/1.5	1.5	2.2/3	3	3.7/4	4	5.5	7.5	7.5
400/415V [kW]	0.02	0.06	0.09	0.12	0.18/0.25	0.37/0.55	0.75	1.1/1.5	2.2	3	3.7/4	5.5	7.5	7.5	22	15	18.5
500V [kW]	-	-	-	0.25	0.25	0.55/0.75	1.1	1.5/2.2	3	3.7	4/5.5	7.5	11	11	15	18.5	22
690V [kW]	-	-	-	0.25	0.37/0.55	0.75/1.1	1.5	2.2/3	3.7/4	5.5	7.5	11	11	11	18.5	22	30
Back-up fuses gG, gL, only if Icc>Icu (* = No back up fuse required)																	
230/240V [kA]	*	*	*	*	*	*	*	*	*	*	*	*	*	125	125	125	125
400/415V [kA]	*	*	*	*	*	*	*	*	*	*	80	80	100	100	100	100	100
400/460V [kA]	*	*	*	*	*	*	*	50	50	63	63	80	80	100	100	100	100
500V [kA]	*	*	*	*	*	*	50	40	50	63	63	80	80	80	80	80	80
690V [kA]	*	*	*	*	*	20	35	40	50	63	63	63	63	63	63	63	63
Ultimate short-circuit breaking capacity Icu																	
230/240V [kA]	100	100	100	100	100	100	100	100	100	100	100	100	50	40	40	30	20
400/415V [kA]	100	100	100	100	100	100	100	100	100	100	50	50	20	15	15	15	10
440/460V [kA]	100	100	100	100	100	100	100	50	15	15	15	10	10	8	8	6	5
500V [kA]	100	100	100	100	100	100	50	15	10	10	6	6	6	6	6	5	4
690V [kA]	100	100	100	100	100	3	3	3	3	3	3	3	3	3	3	3	2
Rated service short-circuit breaking capacity Ics																	
230/240V [kA]	100	100	100	100	100	100	100	100	100	100	100	100	38	30	30	22	15
400/415V [kA]	100	100	100	100	100	100	100	100	100	100	38	38	15	11	11	11	8
440/460V [kA]	100	100	100	100	100	100	100	38	11	11	11	8	8	6	6	4	3
500V [kA]	100	100	100	100	100	100	38	11	8	8	5	5	5	5	5	4	3
690V [kA]	100	100	100	100	100	3	3	3	3	3	3	3	3	3	3	3	2

### Standard type MMS-63S

Rated operational current Ie	10	13	17	22	26	32	40	50	63	65
Switching of standard three-phase motors AC-2, AC-3										
230/240V [kW]	2.2/3	3	3.7/4	4	5.5	7.5	7.5	11	15	15
400/415V [kW]	3.7/4	5.5	7.5	7.5	11	15	18.5	22	30	30
500V [kW]	4.5/5	7.5	11	11	15	18.5	22	30	37	37
690V [kW]	7.5	11	11	15	18.5	22	30	45	55	55
Back-up fuses gG, gL, only if Icc>Icu (* = No back up fuse required)										
230/240V [kA]	*	*	*	125	125	160	160	200	200	200
400/415V [kA]	*	80	100	125	125	125	160	160	160	160
400/460V [kA]	80	80	100	100	100	100	100	125	125	125
500V [kA]	80	80	80	80	80	80	80	80	80	80
690V [kA]	63	63	63	63	63	63	63	63	80	60
Ultimate short-circuit breaking capacity Icu										
230/240V [kA]	100	100	100	50	50	50	50	50	50	50
400/415V [kA]	100	50	25	25	25	25	25	25	25	25
440/460V [kA]	15	10	10	10	10	10	10	10	10	10
500V [kA]	10	6	6	6	6	6	6	6	6	6
690V [kA]	4	4	4	4	4	4	4	4	4	4
Rated service short-circuit breaking capacity Ics										
230/240V [kA]	100	100	100	38	38	38	38	38	38	38
400/415V [kA]	100	38	19	19	19	19	19	19	19	19
440/460V [kA]	12	8	8	8	8	8	8	8	8	8
500V [kA]	8	5	5	5	5	5	5	5	5	5
690V [kA]	3	3	3	3	3	3	3	3	3	3

### Standard type MMS-100S

Rated operational current Ie	17	22	26	32	40	50	63	75	90	100
Switching of standard three-phase motors AC-2, AC-3										
230/240V [kW]	3.7/4	4	5.5	7.5	7.5	11	15	22	30	30
400/415V [kW]	7.5	7.5	11	15	18.5	22	30	37	45	45
500V [kW]	11	11	15	18.5	22	30	37	45	55	63
690V [kW]	11	15	18.5	22	30	45	55	63	75	90
Back-up fuses gG, gL, only if Icc>Icu (* = No back up fuse required)										
230/240V [kA]	*	*	*	*	*	*	*	*	*	*
400/415V [kA]	100	125	125	125	160	160	160	160	160	160
400/460V [kA]	100	125	125	125	125	160	160	160	160	160
500V [kA]	100	100	100	100	100	100	100	125	125	125
690V [kA]	63	80	80	80	80	80	80	100	125	125
Ultimate short-circuit breaking capacity Icu										
230/240V [kA]	100	100	100	100	100	100	100	100	100	100
400/415V [kA]	50	50	50	50	50	50	50	50	50	50
440/460V [kA]	40	40	40	40	40	40	40	40	40	40
500V [kA]	25	25	25	15	15	12	12	8	8	8
690V [kA]	10	10	10	10	6	6	6	5	5	5
Rated service short-circuit breaking capacity Ics										
230/240V [kA]	100	100	100	100	100	100	100	100	100	100
400/415V [kA]	38	38	38	38	38	38	38	38	38	38
440/460V [kA]	30	30	30	30	30	30	30	30	30	30
500V [kA]	19	19	19	11	11	9	9	6	6	6
690V [kA]	8	8	8	8	5	5	5	4	4	4

# Technical Information

## IEC performance data (Motor protection)

### High breaking type MMS-32H

Rated operational current Ie	0.16	0.25	0.4	0.63	1	1.6	2.5	4	6	8	10	13	17	22	26	32	40
Switching of standard three-phase motors AC-2, AC-3																	
230/240V [kW]	-	0.03	0.06	0.09	0.12	0.18/0.25	0.37/0.55	0.55/0.75	1.1/1.5	1.5	2.2/3	3	3.7/4	5.5	7.5	11	15
400/415V [kW]	0.02	0.06	0.09	0.12	0.18/0.25	0.37/0.5	0.55/0.75	1.1/1.5	2.2	3	3.7/4	5.5	7.5	11	15	18.5	22
500V [kW]	-	-	-	0.25	0.37	0.55/0.75	1.1	1.5/2.2	3	3.7	4/5.5	7.5	11	11	15	18.5	22
690V [kW]	-	-	-	0.25	0.37/0.55	0.75/1.1	1.5	2.2/3	3.7/4	5.5	7.5	11	11	15	18.5	22	30
Back-up fuses gG, gL, only if Icc>Icu (* = No back up fuse required)																	
230/240V [kA]	*	*	*	*	*	*	*	*	*	*	*	*	*	*	*	*	*
400/415V [kA]	*	*	*	*	*	*	*	*	*	*	*	*	100	125	125	125	160
400/460V [kA]	*	*	*	*	*	*	*	*	*	80	80	80	80	100	100	100	125
500V [kA]	*	*	*	*	*	*	*	*	*	63	80	80	80	80	80	80	100
690V [kA]	*	*	*	*	*	*	35	40	50	63	63	63	63	63	63	63	80
Ultimate short-circuit breaking capacity Icu																	
230/240V [kA]	100	100	100	100	100	100	100	100	100	100	100	100	100	100	100	100	100
400/415V [kA]	100	100	100	100	100	100	100	100	100	100	100	100	50	50	50	50	40
440/460V [kA]	100	100	100	100	100	100	100	100	100	50	50	50	25	25	25	25	15
500V [kA]	100	100	100	100	100	100	100	100	100	50	50	42	10	10	10	10	8
690V [kA]	100	100	100	100	100	100	8	8	6	6	6	6	4	4	4	4	3
Rated service short-circuit breaking capacity Ics																	
230/240V [kA]	100	100	100	100	100	100	100	100	100	100	100	100	100	100	100	100	100
400/415V [kA]	100	100	100	100	100	100	100	100	100	100	100	100	38	38	38	38	30
440/460V [kA]	100	100	100	100	100	100	100	100	100	38	38	38	15	15	15	15	11
500V [kA]	100	100	100	100	100	100	100	100	100	38	38	32	8	8	8	8	6
690V [kA]	100	100	100	100	100	100	8	8	6	6	6	6	4	4	4	4	3

### High breaking type MMS-63H

Rated operational current Ie	10	13	17	22	26	32	40	50	63	65
Switching of standard three-phase motors AC-2, AC-3										
230/240V [kW]	2.2/3	3	3.7/4	4	5.5	7.5	7.5	11	15	15
400/415V [kW]	3.7/4	5.5	7.5	7.5	11	15	18.5	22	30	30
500V [kW]	4/5.5	7.5	11	11	15	18.5	22	30	37	37
690V [kW]	7.5	11	11	15	18.5	22	30	45	55	55
Back-up fuses gG, gL, only if Icc>Icu (* = No back up fuse required)										
230/240V [kA]	*	*	*	*	*	*	*	*	*	*
400/415V [kA]	*	*	100	125	125	125	160	160	160	160
400/460V [kA]	100	100	100	125	125	125	125	125	160	160
500V [kA]	100	100	100	100	100	100	100	100	100	100
690V [kA]	63	63	63	80	80	80	80	80	80	80
Ultimate short-circuit breaking capacity Icu										
230/240V [kA]	100	100	100	100	100	100	100	100	100	75
400/415V [kA]	100	100	50	50	50	50	50	50	50	35
440/460V [kA]	50	50	50	50	35	35	35	35	35	25
500V [kA]	50	42	12	12	12	10	10	10	10	6
690V [kA]	6	6	5	5	5	5	5	5	5	3
Rated service short-circuit breaking capacity Ics										
230/240V [kA]	100	100	100	100	100	100	100	100	100	50
400/415V [kA]	100	100	50	50	50	50	50	50	50	27
440/460V [kA]	38	38	38	38	27	27	27	27	27	19
500V [kA]	38	32	9	9	9	8	8	8	8	5
690V [kA]	5	5	5	5	5	5	5	5	5	3

### High breaking type MMS 100H

Rated operational current Ie	17	22	26	32	40	50	63	75	90	100
Switching of standard three-phase motors AC-2, AC-3										
230/240V [kW]	3.7/4	4	5.5	7.5	11	15	15	22	30	30
400/415V [kW]	7.5	7.5	11	18.5	22	30	30	37	45	45
500V [kW]	11	11	15	22	30	37	37	45	56	63
690V [kW]	11	15	18.5	30	45	55	55	63	75	90
Back-up fuses gG, gL, only if Icc>Icu (* = No back up fuse required)										
230/240V [kA]	*	*	*	*	*	*	*	*	*	*
400/415V [kA]	*	*	*	*	*	*	*	*	*	*
400/460V [kA]	125	125	125	160	160	160	200	200	200	200
500V [kA]	100	125	125	125	160	160	160	160	160	160
690V [kA]	80	80	80	80	80	100	100	125	160	160
Ultimate short-circuit breaking capacity Icu										
230/240V [kA]	100	100	100	100	100	100	100	100	100	100
400/415V [kA]	100	100	100	100	100	100	100	75	75	75
440/460V [kA]	50	50	50	50	50	50	50	50	50	50
500V [kA]	35	35	35	25	20	15	15	12	12	12
690V [kA]	12	12	12	12	12	10	8	6	6	6
Rated service short-circuit breaking capacity Ics										
230/240V [kA]	100	100	100	100	100	100	100	100	100	100
400/415V [kA]	100	50	50	50	50	50	50	50	50	50
440/460V [kA]	38	38	38	38	38	38	38	38	38	38
500V [kA]	27	27	27	19	15	11	11	9	9	9
690V [kA]	9	9	9	9	9	8	6	6	6	6

Note) \* = Short circuit proof up to 50 or 100kA. No back up fuse required.

High breaking type MMS-32HI

Rated operational current Ie	0.16	0.25	0.4	0.63	1	1.6	2.5	4	6	8	10	13	17	22	26	32	40
AC-2, AC-3																	
230/240V [kW]	-	0.03	0.06	0.09	0.12	0.18/0.25	0.37	0.55/0.75	1.1/1.5	1.5	2.2/3	3	3.7/4	4	5.5	7.5	7.5
400/415V [kW]	0.02	0.06	0.09	0.12	0.18/0.25	0.37/0.55	0.75	1.1/1.5	2.2	3	3.7/4	5.5	7.5	7.5	11	15	18.5
500V [kW]	-	-	-	0.25	0.37	0.55/0.75	1.1	1.5/2.2	3	3.7	4/5.5	7.5	11	11	15	18.5	22
690V [kW]	-	-	-	0.25	0.37/0.55	0.75/1.1	1.5	2.2/3	3.7/4	5.5	7.5	11	11	15	18.5	22	30
Back-up fuses gG, gL, only if Icc>Icu (* = No back up fuse required)																	
230/240V [kA]	*	*	*	*	*	*	*	*	*	*	*	*	*	*	*	*	*
400/415V [kA]	*	*	*	*	*	*	*	*	*	*	*	*	100	125	125	125	160
400/460V [kA]	*	*	*	*	*	*	*	*	*	80	80	80	100	100	100	100	125
500V [kA]	*	*	*	*	*	*	*	*	*	63	80	80	80	80	80	80	100
690V [kA]	*	*	*	*	*	*	35	40	50	63	63	63	63	63	63	63	80
Ultimate short-circuit breaking capacity Icu																	
230/240V [kA]	100	100	100	100	100	100	100	100	100	100	100	100	100	100	100	100	100
400/415V [kA]	100	100	100	100	100	100	100	100	100	100	100	100	100	100	50	50	40
440/460V [kA]	100	100	100	100	100	100	100	100	100	50	50	50	25	25	25	25	15
500V [kA]	100	100	100	100	100	100	100	100	100	50	50	42	10	10	10	10	8
690V [kA]	100	100	100	100	100	100	8	8	6	6	6	6	4	4	4	4	3
Rated service short-circuit breaking capacity Ics																	
230/240V [kA]	100	100	100	100	100	100	100	100	100	100	100	100	100	100	100	100	100
400/415V [kA]	100	100	100	100	100	100	100	100	100	100	100	100	38	38	38	38	30
440/460V [kA]	100	100	100	100	100	100	100	100	100	38	38	38	15	15	15	15	11
500V [kA]	100	100	100	100	100	100	100	100	100	38	38	32	8	8	8	8	6
690V [kA]	100	100	100	100	100	100	8	8	6	6	6	6	4	4	4	4	3

High breaking type MMS-63HI

Rated operational current Ie	10	13	17	22	26	32	40	50	63	65
AC-2, AC-3										
230/240V [kW]	2.2/3	3	3.7/4	4	5.5	7.5	7.5	11	15	15
400/415V [kW]	3.7/4	5.5	7.5	7.5	11	15	18.5	22	30	30
500V [kW]	4/5.5	7.5	11	11	15	18.5	22	30	37	37
690V [kW]	7.5	11	11	15	18.5	22	30	45	55	55
Back-up fuses gG, gL, only if Icc>Icu (* = No back up fuse required)										
230/240V [kA]	*	*	*	*	*	*	*	*	*	*
400/415V [kA]	*	*	100	125	125	125	160	160	160	160
400/460V [kA]	100	100	100	125	125	125	160	125	160	160
500V [kA]	100	100	100	100	100	100	100	100	100	100
690V [kA]	63	63	63	80	80	80	80	80	80	80
Ultimate short-circuit breaking capacity Icu										
230/240V [kA]	100	100	100	100	100	100	100	100	100	75
400/415V [kA]	100	100	50	50	50	50	50	50	50	35
440/460V [kA]	50	50	50	50	35	35	35	35	35	25
500V [kA]	50	42	12	12	10	10	10	10	10	6
690V [kA]	6	6	5	5	5	5	5	5	5	3
Rated service short-circuit breaking capacity Ics										
230/240V [kA]	100	100	100	100	100	100	100	100	100	50
400/415V [kA]	100	100	50	50	50	50	50	50	50	27
440/460V [kA]	38	38	38	38	27	27	27	27	27	19
500V [kA]	38	32	9	9	9	8	8	8	8	5
690V [kA]	5	5	5	5	5	5	5	5	5	3

High breaking type MMS-100HI

Rated operational current Ie	17	22	26	32	40	50	63	75	90	100
AC-2, AC-3										
230/240V [kW]	3.7/4	4	5.5	7.5	7.5	11	15	22	30	30
400/415V [kW]	7.5	7.5	11	15	18.5	22	30	37	45	45
500V [kW]	11	11	15	18.5	22	30	37	45	55	63
690V [kW]	11	15	18.5	22	30	45	55	63	75	90
Back-up fuses gG, gL, only if Icc>Icu (* = No back up fuse required)										
230/240V [kA]	*	*	*	*	*	*	*	*	*	*
400/415V [kA]	*	*	*	*	*	*	*	*	*	*
400/460V [kA]	125	125	125	160	160	160	200	200	200	200
500V [kA]	100	125	125	125	160	160	160	160	160	160
690V [kA]	80	80	80	80	80	100	100	125	160	160
Ultimate short-circuit breaking capacity Icu										
230/240V [kA]	100	100	100	100	100	100	100	100	100	100
400/415V [kA]	100	100	100	100	100	100	100	75	75	75
440/460V [kA]	50	50	50	50	50	50	50	50	50	50
500V [kA]	35	35	35	25	20	15	15	12	12	12
690V [kA]	12	12	12	12	12	10	8	6	6	6
Rated service short-circuit breaking capacity Ics										
230/240V [kA]	100	100	100	100	100	100	100	100	100	100
400/415V [kA]	100	50	50	50	50	50	50	50	50	50
D440/460V [kA]	38	38	38	38	38	38	38	38	38	38
500V [kA]	27	27	27	19	15	11	11	9	9	6
690V [kA]	9	9	9	9	9	8	6	6	6	6

# Technical Information

## Manual motor controller (UL 508, CSA C22.2 as manual motor controllers)

### Type E starte

#### MMS-63S

Rated operational current Ie			10	13	17	22	26	32	40	50	63	65
Max. short-circuit current												
240V	[kA]		100	100	100	100	100	100	100	100	100	100
480V	[kA]		50	50	40	40	40	40	40	40	40	40
600V	[kA]		10	10	10	10	10	10	10	10	10	10
Motor load												
1Ø	115V	[HP]	1/2	1/2	1	1½	2	2	3	3	5	5
	230V	[HP]	1½	2	3	3	3	5	7½	10	10	10
3Ø	200V	[HP]	2	3	3	5	7½	7½	10	15	20	20
	230V	[HP]	3	3	5	7½	7½	10	10	15	20	20
	460V	[HP]	5	7½	10	15	15	20	30	30	40	40
	575V	[HP]	7½	10	15	20	20	30	30	40	60	60
Maximum rated current of fuse or breaker		[A]	600	600	600	600	600	600	600	600	600	600

#### MMS-100S

Rated operational current Ie			17	22	26	32	40	50	63	75	90	100
Max. short-circuit current												
240V	[kA]		100	100	100	100	100	100	100	100	100	100
480V	[kA]		50	50	50	50	50	50	40	40	40	40
600V	[kA]		10	10	10	10	10	10	10	10	10	10
Motor load												
1Ø	115V	[HP]	1	1½	2	2	3	3	5	5	7½	10
	230V	[HP]	3	3	3	5	7½	10	10	15	20	20
3Ø	200V	[HP]	3	5	7½	7½	10	15	20	20	25	30
	230V	[HP]	5	7	7½	10	10	15	20	25	30	30
	460V	[HP]	10	15	15	20	30	30	40	50	60	75
	575V	[HP]	15	20	20	30	30	40	60	60	75	100
Maximum rated current of fuse or breaker		[A]	1000	1000	1000	1000	1000	1000	1000	1000	1000	1000

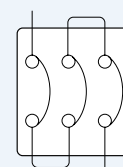

In case of 1-phase use  
in series as shown below



MMS-32H

Rated operational current I <sub>e</sub>			0.16	0.25	0.4	0.63	1	1.6	2.5	4	6	8	10	13	17	22	26	32	40	
Max. short-circuit current																				
240V	[kA]		100	100	100	100	100	100	100	100	100	100	100	100	100	100	100	100	100	100
480V	[kA]		65	65	65	65	65	65	65	65	65	65	65	65	30	30	30	30	30	30
600V	[kA]		25	25	25	25	25	25	25	25	25	25	25	25	10	10	10	10	10	10
Motor load																				
1Ø	115V	[HP]	-	-	-	-	-	-	-	1/8	1/4	1/3	1/2	1/2	1	1½	2	2	3	
	230V	[HP]	-	-	-	-	-	1/10	1/6	1/3	1/2	1	1½	2	3	3	3	5	7½	
3Ø	200V	[HP]	-	-	-	-	-	-	1/2	3/4	1	2	2	3	3	5	7½	7½	10	
	230V	[HP]	-	-	-	-	-	-	1/2	3/4	1½	2	3	3	5	7½	7½	10	10	
	460V	[HP]	-	-	-	-	-	3/4	1	2	3	5	5	7½	10	15	15	20	30	
	575V	[HP]	-	-	-	-	1/2	3/4	1½	3	5	5	7½	10	15	20	20	30	30	
Maximum rated current of fuse or breaker			[A]	500	500	500	500	500	500	500	500	500	500	500	500	500	500	500	500	500

MMS-63H

Rated operational current I <sub>e</sub>			10	13	17	22	26	32	40	50	63	65
Max. short-circuit current												
240V	[kA]		100	100	100	100	100	100	100	100	100	100
480V	[kA]		65	65	50	50	50	50	50	50	50	50
600V	[kA]		25	25	10	10	10	10	10	10	10	10
Motor load												
1Ø	115V	[HP]	1/2	1/2	1	1½	2	2	3	3	5	5
	230V	[HP]	1½	2	3	3	3	5	7½	10	10	10
3Ø	200V	[HP]	2	3	3	5	7½	7½	10	15	20	20
	230V	[HP]	3	3	5	7½	7½	10	10	15	20	20
	460V	[HP]	5	7½	10	15	15	20	30	30	40	40
	575V	[HP]	7½	10	15	20	20	30	30	40	60	60
Maximum rated current of fuse or breaker			[A]	600	600	600	600	600	600	600	600	600

MMS-100H

Rated operational current I <sub>e</sub>			17	22	26	32	40	50	63	75	90	100
Max. short-circuit current												
240V	[kA]		100	100	100	100	100	100	100	100	100	100
480V	[kA]		65	65	65	65	65	65	50	50	50	50
600V	[kA]		25	25	25	20	20	20	10	10	10	10
Motor load												
1Ø	115V	[HP]	1	1½	2	2	3	3	5	5	7½	10
	230V	[HP]	3	3	3	5	7½	10	10	15	20	20
3Ø	200V	[HP]	3	5	7½	7½	10	15	20	20	25	30
	230V	[HP]	5	7½	7½	10	10	15	20	25	30	30
	460V	[HP]	10	15	15	20	30	30	40	50	60	75
	575V	[HP]	15	20	20	30	30	40	60	60	75	100
Maximum rated current of fuse or breaker			[A]	1000	1000	1000	1000	1000	1000	1000	1000	1000

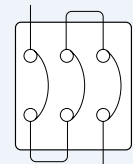

In case of 1-phase use in series as shown below

# Technical Information

## Manual motor controller (UL 508)

### MMS-32S

Rated operational current Ie		0.16	0.25	0.4	0.63	1	1.6	2.5	4	6	8	10	13	17	22	26	32	40	
Max. short-circuit current																			
240V	[kA]	100	100	100	100	100	100	100	100	100	100	50	50	40	30	30	20	20	
480V	[kA]	50	50	50	50	50	50	50	50	25	25	10	10	10	10	7.5	7.5	7.5	
600V	[kA]	10	10	10	10	10	10	10	5	5	5	5	5	5	5	5	5	5	
Motor load																			
1Ø	115V	[HP]	-	-	-	-	-	-	1/8	1/4	1/3	1/2	1/2	1	1½	2	2	3	
	230V	[HP]	-	-	-	-	1/10	1/6	1/3	1/2	1	1½	2	3	3	3	5	7½	
3Ø	200V	[HP]	-	-	-	-	-	1/2	3/4	1	2	2	3	3	5	7½	7½	10	
	230V	[HP]	-	-	-	-	-	1/2	3/4	1½	2	3	3	5	7½	7½	10	10	
	460V	[HP]	-	-	-	-	3/4	1	2	3	5	5	7½	10	15	15	20	30	
	575V	[HP]	-	-	-	-	1/2	3/4	1½	3	5	5	7½	10	15	20	20	30	
Max. fuse size		[A]	1	1	1	3	6	10	15	20	30	40	50	60	80	100	125	150	
Max. breaker size		[A]	15	15	15	15	15	15	15	20	30	40	50	60	80	100	125	150	

### MMS-63S

Rated operational current Ie		10	13	17	22	26	32	40	50	63	65	
Max. short-circuit current												
240V	[kA]	100	100	100	100	100	100	100	100	100	100	
480V	[kA]	25	25	25	25	25	25	25	25	25	25	
600V	[kA]	10	10	10	10	10	10	10	10	10	10	
Motor load												
1Ø	115V	[HP]	1/2	1/2	1	1½	2	2	3	3	5	5
	230V	[HP]	1½	2	3	3	3	5	7½	10	10	10
3Ø	200V	[HP]	2	3	3	5	7½	7½	10	15	20	20
	230V	[HP]	3	3	5	7½	7½	10	10	15	20	20
	460V	[HP]	5	7½	10	15	15	20	30	30	40	40
	575V	[HP]	7½	10	15	20	20	30	30	40	60	60
Max. fuse size		[A]	40	50	60	80	100	125	150	200	250	250
Max. breaker size		[A]	40	50	60	80	100	125	150	200	250	250

### MMS-100S

Rated operational current Ie		17	22	26	32	40	50	63	75	90	100	
Max. short-circuit current												
240V	[kA]	100	100	100	100	100	100	100	100	100	100	
480V	[kA]	25	25	25	25	25	25	25	25	25	25	
600V	[kA]	10	10	10	10	10	10	10	10	10	10	
Motor load												
1Ø	115V	[HP]	1	1½	2	2	3	3	5	5	7½	10
	230V	[HP]	3	3	3	5	7½	10	10	15	20	20
3Ø	200V	[HP]	3	5	7½	7½	10	15	20	20	25	30
	230V	[HP]	5	7½	7½	10	10	15	20	25	30	30
	460V	[HP]	10	15	15	20	30	30	40	50	60	75
	575V	[HP]	15	20	20	30	30	40	60	60	75	100
Max. fuse size		[A]	60	80	100	125	150	200	250	300	350	400
Max. breaker size		[A]	60	80	100	125	150	200	250	300	350	400

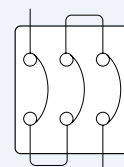

In case of 1-phase use  
in series as shown below

**MMS-32H**

Rated operational current I <sub>e</sub>		0.16	0.25	0.4	0.63	1	1.6	2.5	4	6	8	10	13	17	22	26	32	40	
Max. short-circuit current																			
240V	[kA]	100	100	100	100	100	100	100	100	100	100	100	100	100	100	100	100	100	100
480V	[kA]	50	50	50	50	50	50	50	50	50	50	50	50	30	30	30	30	30	30
600V	[kA]	10	10	10	10	10	10	10	10	10	10	10	10	10	10	10	10	10	10
Motor load																			
1Ø	115V [HP]	-	-	-	-	-	-	-	1/8	1/4	1/3	1/2	1/2	1	1½	2	2	3	
	230V [HP]	-	-	-	-	-	1/10	1/6	1/3	1/2	1	1½	2	3	3	3	5	7½	
3Ø	200V [HP]	-	-	-	-	-	-	1/2	3/4	1	2	2	3	3	5	7½	7½	10	
	230V [HP]	-	-	-	-	-	-	1/2	3/4	1½	2	3	3	5	7½	7½	10	10	
	460V [HP]	-	-	-	-	-	3/4	1	2	3	5	5	7½	10	15	15	20	30	
	575V [HP]	-	-	-	-	1/2	3/4	1½	3	5	5	7½	10	15	20	20	30	30	
Max. fuse size	[A]	1	1	1	1	3	6	10	15	20	30	40	50	60	80	100	125	150	
Max. breaker size	[A]	15	15	15	15	15	15	15	15	20	30	40	50	60	80	100	125	150	

**MMS-63H**

Rated operational current I <sub>e</sub>		10	13	17	22	26	32	40	50	63	65
Max. short-circuit current											
240V	[kA]	100	100	100	100	100	100	100	100	100	100
480V	[kA]	50	50	50	50	50	50	50	50	50	50
600V	[kA]	10	10	10	10	10	10	10	10	10	10
Motor load											
1Ø	115V [HP]	1/2	1/2	1	1½	2	2	3	3	5	5
	230V [HP]	1½	2	3	3	3	5	7½	10	10	10
3Ø	200V [HP]	2	3	3	5	7½	7½	10	15	20	20
	230V [HP]	3	3	5	7½	7½	10	10	15	20	20
	460V [HP]	5	7½	10	15	15	20	30	30	40	40
	575V [HP]	7½	10	15	20	20	30	30	40	60	60
Max. fuse size	[A]	40	50	60	80	100	125	150	200	250	250
Max. breaker size	[A]	40	50	60	80	100	125	150	200	250	250

**MMS-100H**

Rated operational current I <sub>e</sub>		17	22	26	32	40	50	63	75	90	100
Max. short-circuit current											
240V	[kA]	100	100	100	100	100	100	100	100	100	100
480V	[kA]	50	50	50	50	50	50	50	50	50	50
600V	[kA]	10	10	10	10	10	10	10	10	10	10
Motor load											
1Ø	115V [HP]	1	1½	2	2	3	3	5	5	7½	10
	230V [HP]	3	3	3	5	7½	10	10	15	20	20
3Ø	200V [HP]	3	5	7½	7½	10	15	20	20	25	30
	230V [HP]	5	7½	7½	10	10	15	20	25	30	30
	460V [HP]	10	15	15	20	30	30	40	50	60	75
	575V [HP]	15	20	20	30	30	40	60	60	75	100
Max. fuse size	[A]	60	80	100	125	150	200	250	300	350	400
Max. breaker size	[A]	60	80	100	125	150	200	250	300	350	400

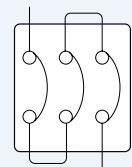

In case of 1-phase use in series as shown below

# Technical Information

## Type '2' coordination according to IEC60947-4-1

Short-circuit Current I<sub>q</sub> : 50kA

Voltage : 400/415V, 50/60Hz

Standard Motors AC at 400/415V 1500rpm		Manual motor starter			Contactor	
		Circuit breaker	Thermal overload release setting range	Magnetic release response current		
[kW]	[A]	Type	[A]	[A]	Type	[A]
-	-	MMS-32S 0.16A	0.1~0.16	2.1	GMC-6M / MC-9a / MC-9b	6 / 9
0.06	0.2	MMS-32S 0.25A	0.16~0.25	3.3	GMC-6M / MC-9a / MC-9b	6 / 9
0.09	0.3	MMS-32S 0.4A	0.25~0.4	5.2	GMC-6M / MC-9a / MC-9b	6 / 9
0.12	0.4	MMS-32S 0.63A	0.4~0.63	8.2	GMC-6M / MC-9a / MC-9b	6 / 9
0.18	0.6	MMS-32S 1A	0.63~1	13	GMC-6M / MC-9a / MC-9b	6 / 9
0.25	0.8	MMS-32S 1A	0.63~1	13	GMC-6M / MC-9a / MC-9b	6 / 9
0.37	1.1	MMS-32S 1.6A	1~1.6	20.8	GMC-6M / MC-9a / MC-9b	6 / 9
0.55	1.5	MMS-32S 1.6A	1~1.6	20.8	GMC-6M / MC-9a / MC-9b	6 / 9
0.75	1.9	MM-32S 2.5A	1.6~2.5	32.5	MC-12a / MC-12b	12
1.1	2.7	MMS-32S 4A	2.5~4	52	MC-18a / MC-18b	18
1.5	3.6	MMS-32S 4A	2.5~4	52	MC-18a / MC-18b	18
2.2	5.2	MMS-32S 6A	4~6	78	MC-18a / MC-18b	18
3	6.8	MMS-32S 8A	5~8	104	MC-18a / MC-18b	18
4	9	MMS-32S 10A	6~10	130	MC-18a / MC-18b	18
5.5	11.5	MMS-32H 13A	9~13	169	MC-22b	22
7.5	15.5	MMS-32H 17A	11~17	221	MC-22b	22
10	20	MMS-32H 22A	14~22	286	MC-32a	32
11	22	MMS-32H 26A	18~26	338	MC-32a	32
15	29	MMS-32H 32A	22~32	416	MC-32a	32
18.5	35	MMS-63H 40A	28~40	520	MC-40a	40
22	41	MMS-63H 50A	34~50	650	MC-50a	50
30	55	MMS-63H 63A	45~63	819	MC-65a	65
37	67	MMS-100S 75A	55~75	975	MC-75a	75
-	-	MMS-100S 90A	70~90	1170	MC-85a	85
45	80	MMS-100S 100A	80~100	1300	MC-85a	85

### Definition type '2' coordination according to IEC 60947-4-1 :

- The contactor or the starter must not endanger persons or systems in the event of a short-circuit.
- The contactor or the starter must be suitable for further use.
- No damage to the overload relay or other parts may occur with the exception of welding of the contactor or starter contacts provided that these can be easily separated without significant deformation (such as with a screwdriver).

## LS MMS ready for IE3-rated motors

Type	Rated current(A)	Short-circuit current(A)	Current range(A)			Short-circuit current ratio		
			Min	Mid	Max	Min	Mid	Max
32	0.16A	2.1	0.1	0.13	0.16	20.8	16.0	13.0
	0.25A	3.3	0.16	0.2	0.25	20.3	16.3	13.0
	0.4A	5.2	0.25	0.33	0.4	20.8	15.8	13.0
	0.63A	8.2	0.4	0.52	0.63	20.5	15.8	13.0
	1A	13.0	0.63	0.81	1	20.6	16.0	13.0
	1.6A	20.8	1	1.3	1.6	20.8	16.0	13.0
	2.5A	32.5	1.6	2.1	2.5	20.3	15.5	13.0
	4A	52	2.5	3.3	4	20.8	15.8	13.0
	6A	78	4	5	6	19.5	15.6	13.0
	8A	104	5	6.5	8	20.8	16.0	13.0
	10A	130	6	8	10	21.7	16.3	13.0
	13A	169	9	11	13	18.8	15.4	13.0
	17A	221	11	14	17	20.1	15.8	13.0
	22A	286	14	18	22	20.4	15.9	13.0
	26A	338	18	22	26	18.8	15.4	13.0
	32A	416	22	27	32	18.9	15.4	13.0
40A	520	28	34	40	18.6	15.3	13.0	
63	10A	130	6	8	10	21.7	16.3	13.0
	13A	169	9	11	13	18.8	15.4	13.0
	17A	221	11	14	17	20.1	15.8	13.0
	22A	286	14	17	22	20.4	16.8	13.0
	26A	338	18	22	26	18.8	15.4	13.0
	32A	416	22	27	32	18.9	15.4	13.0
	40A	520	28	34	40	18.6	15.3	13.0
	50A	650	34	42	50	19.1	15.5	13.0
	63A	819	45	54	63	18.2	15.2	13.0
	65A	845	47	56	65	18.0	15.1	13.0
100	17A	221	11	14	17	20.1	15.8	13.0
	22A	286	14	18	22	20.4	15.9	13.0
	26A	338	18	22	26	18.8	15.4	13.0
	32A	416	22	27	32	18.9	15.4	13.0
	40A	520	28	34	40	18.6	15.3	13.0
	50A	650	34	42	50	19.1	15.5	13.0
	63A	819	45	54	63	18.2	15.2	13.0
	75A	975	55	65	75	17.7	15.0	13.0
	90A	1170	70	80	90	16.7	14.6	13.0
100A	1300	80	90	100	16.3	14.4	13.0	

# Technical Information

## IE3 De-rating table

### What is the IE3?

Motor is rated from IE1 through IE4 depends on its energy efficiency which means IE3 is more efficient compared to IE1 and IE2-rated motors.

### Why IE3?

As part of the EU Environmental policy "20/30-20-20" strategy, the EU is committed to achieve the followings by 2020.

- Reduce Greenhouse Gas Emissions by Up to 30%
- Increase the Share of Renewable Energy to 20% and
- Boost Energy Efficiency by 20% in General.

IEC 60034-30 standard specifies IE classes for motors in accordance with the above requirements. Therefore, consumers must comply with the standard when using MMS products.

### How to select MMS?

To meet the IE3 motor starting current & Inrush current, use of de-rating table is recommended. (13 times the rated current)

#### Example)

If you select the product A or B...

A : MMS setting scale " 11 ~ 17A

B : MMS setting scale " 14 ~ 22A

Rated motor Current : 16A

The short-circuit current of MMS A is 221A (17\*13), and MMS B is 286A (22\*13).

When applying the motor's rated current(16A) to MMS A, the multiplier of the short-circuit current is 13.8 times. When applying the motor's rated current(16A) to MMS B, the multiplier of the short-circuit current is 17.9 times. If motor of IE3-grade or above is used here, malfunction can be caused due to higher starting current compared to that of IE1, 2-graded motor. Therefore, MMS B is recommended since it has the higher multiplier of the short-circuit current.



# Characteristic curve

[mm]

## Tripping curve

MMS-32D

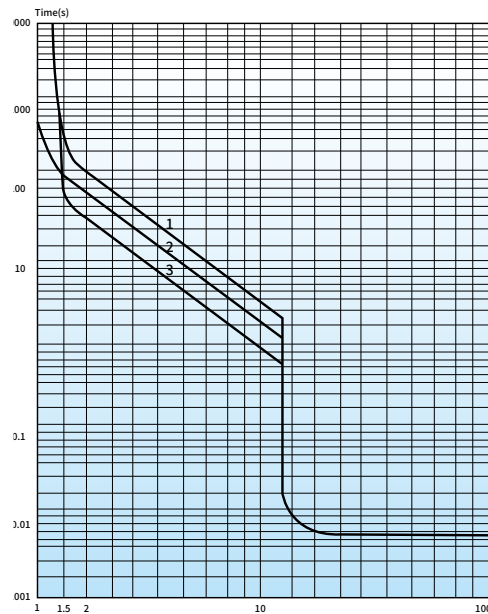

MMS-32AF

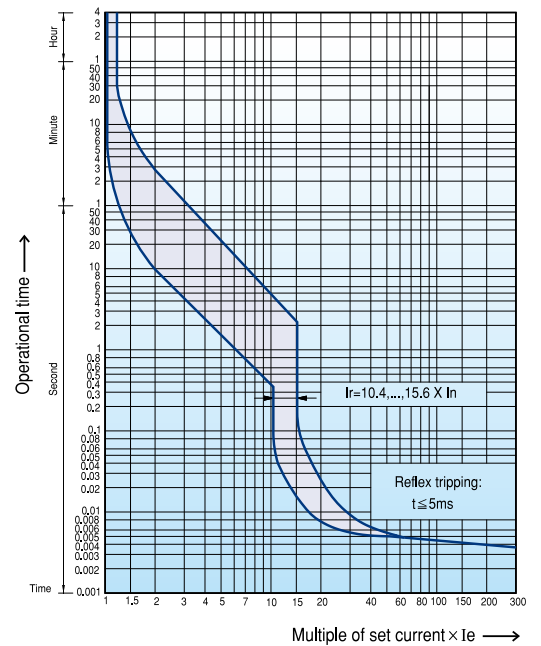

MMS-63, 100AF

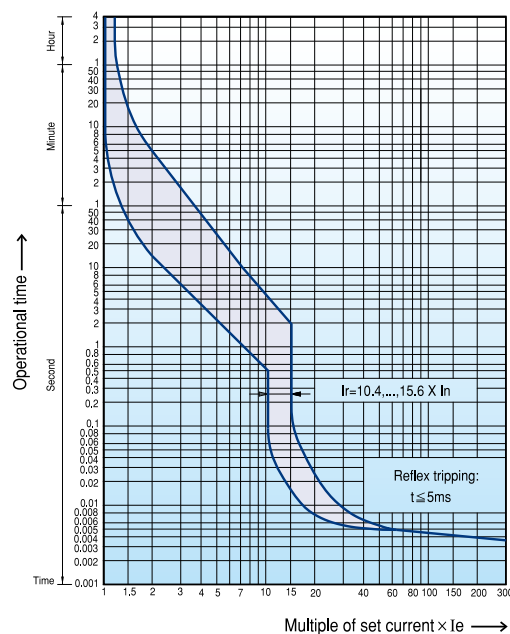

### Thermal release trip current

The adjustable inverse bimetal trip reliability protects motors against overloads. The curve shows the mean operating current at an ambient temperature of 20°C starting from cold. Careful testing and setting ensures effective motor protection even in the case of single-phasing.

### Magnetic release trip current

The instantaneous magnetic trip has a fixed operating current setting. This corresponds to 13 times the maximum value of setting range, at a lower setting it is correspondingly higher.

### Current setting Ie

The overload trip corresponds to a thermal overload relay in a motor starter conforming to IEC 947-4-1. If a different value is prescribed (e.g. reduced Ie for cooling medium having a temperature higher than 40°C or a place of installation higher than 2000m above sea level), the setting current is equal to the reduced rated current Ie of the motor.

## Thermal limit on short-circuit

## Thermal limit in kA<sup>2</sup>s in the magnetic operating zone ( $U_e=415V$ )

MMS-32S/H/Hi

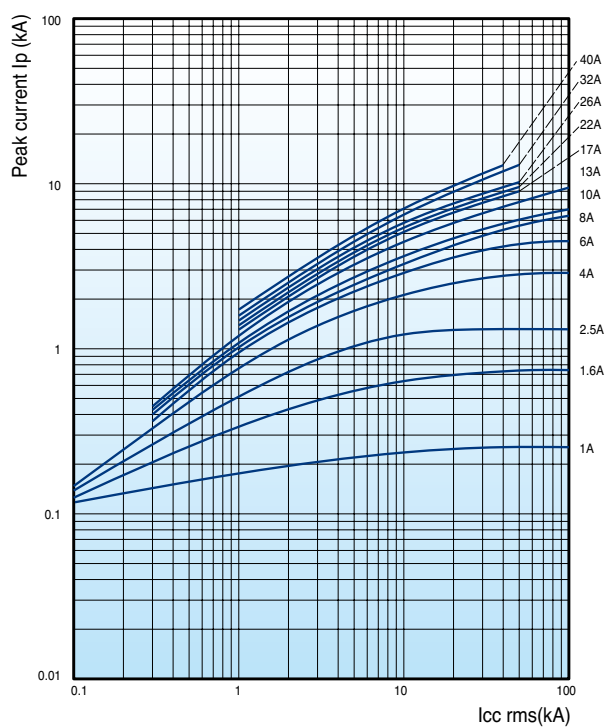
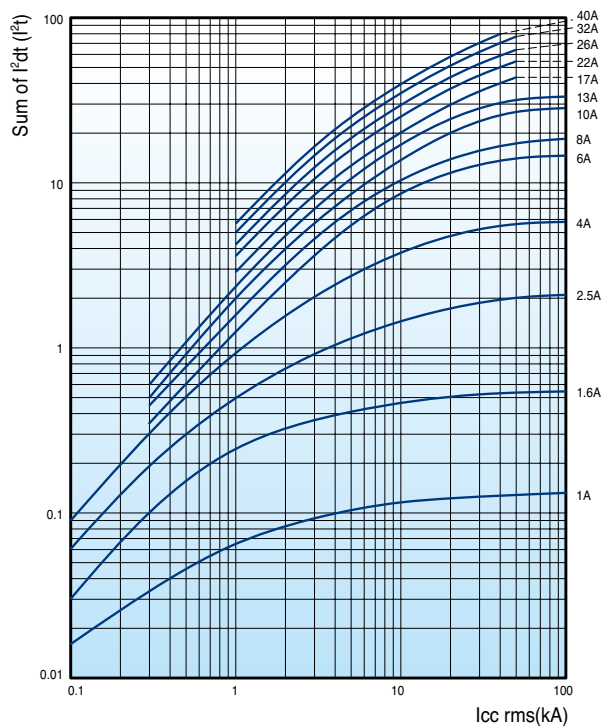



MMS-63S/H/HI

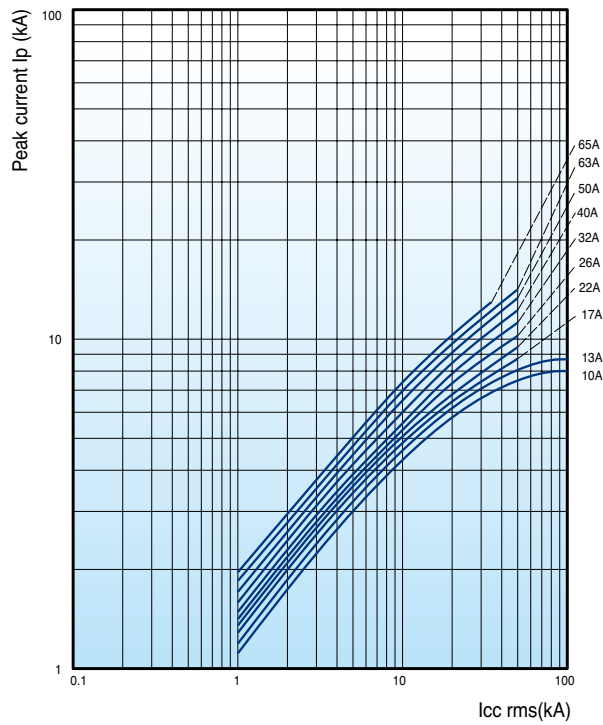
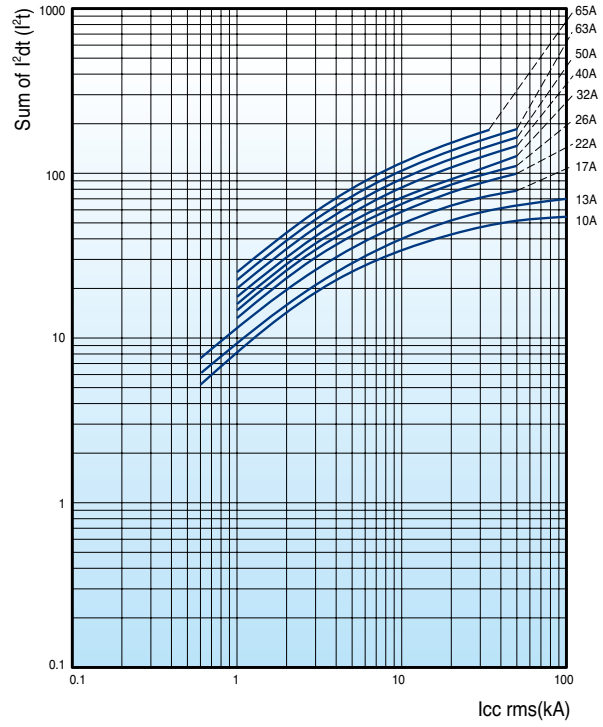

## Thermal limit in kA2s in the magnetic operating zone ( $U_e=415V$ )

MMS-100S/H/HI

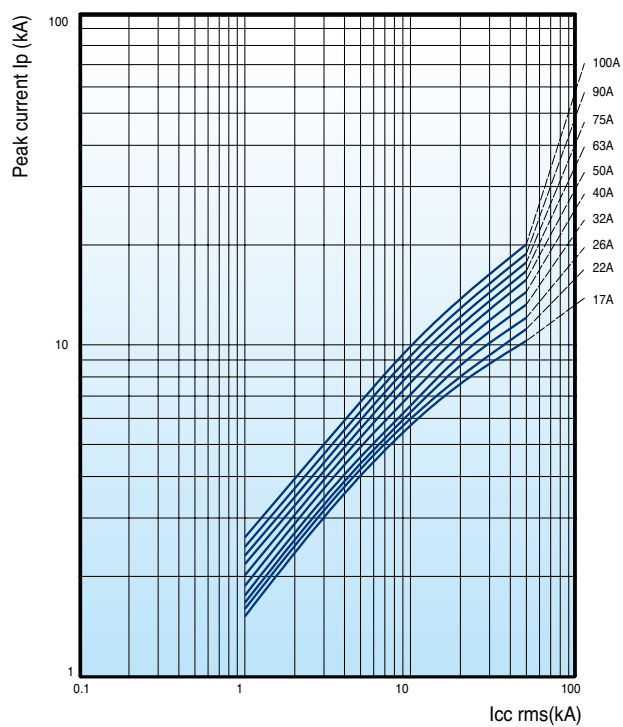
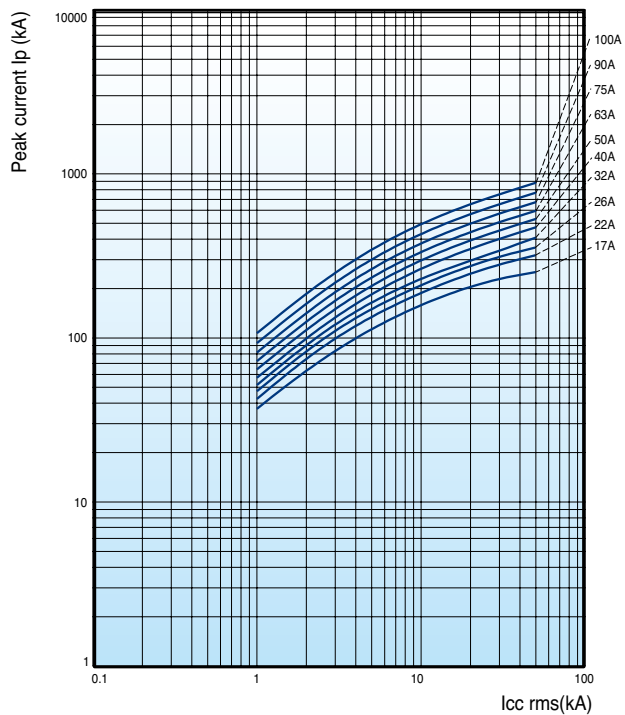

## MMS

[mm]

### MMS-32D

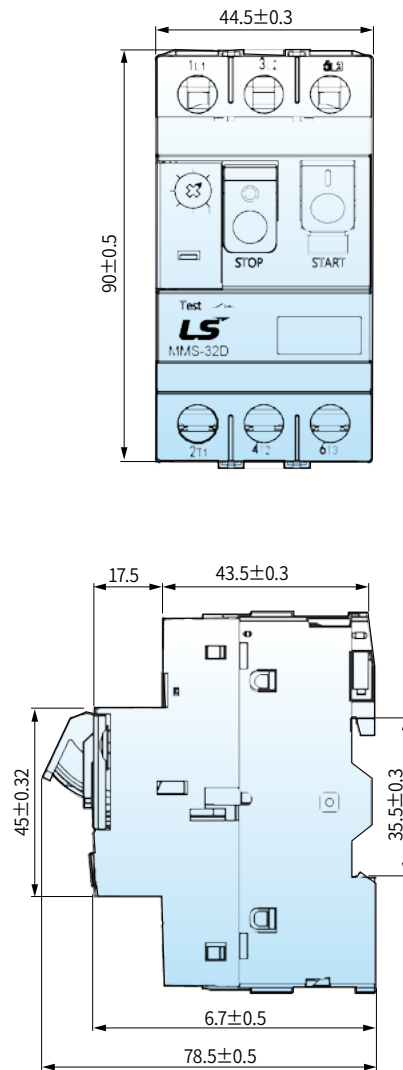

# Dimension

## MMS

[mm]

### MMS-32S

- 1) Side auxiliary switch
- 2) Side magnetic trip alarm switch
- 3) Side shunt release or side undervoltage release
- 4) Front auxiliary switch
- 5) Push-in lugs for screw mounting
- 6) 35mm standard mounting rail acc. to EN 50 022

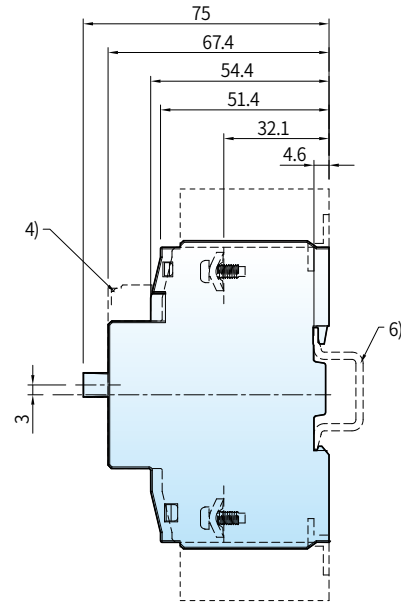
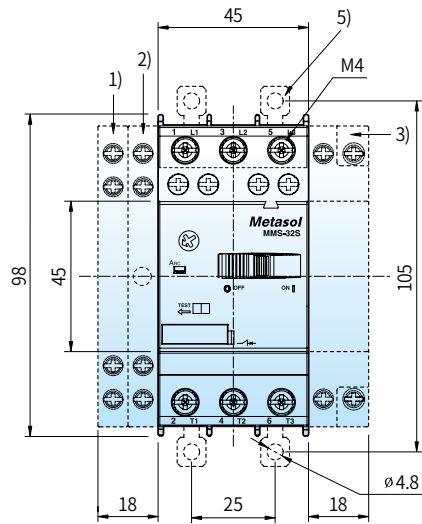

0.32kg

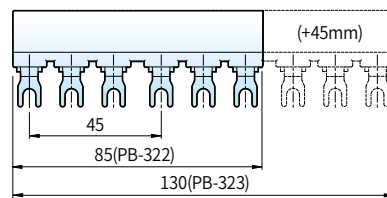
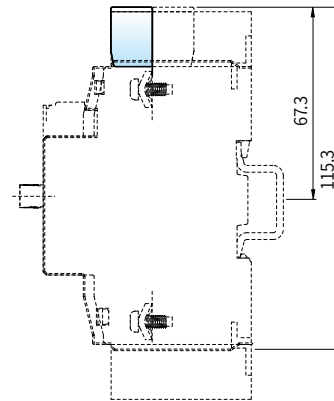
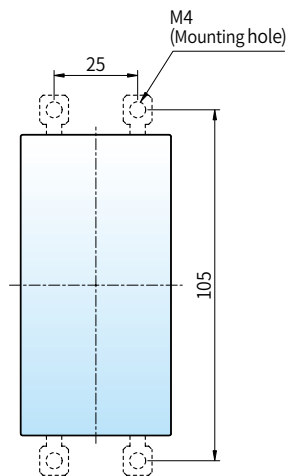

MMS-32S+PB-32  
PB-322 (2 Terminal), PB-323 (3 Terminal)  
PB-324 (4 Terminal), PB-325 (5 Terminal)

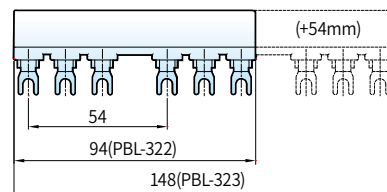

MMS-32S+PBL-32  
PBL-322 (2 Terminal), PBL-323 (3 Terminal)

[mm]

MMS-32H, 32HI

- 1) Side auxiliary switch
- 2) Side magnetic trip alarm switch
- 3) Side shunt release or side undervoltage release
- 4) Front auxiliary switch
- 5) Handle lock in Off position (Ø5mm)
- 6) Push-in lugs for screw mounting
- 7) 35mm standard mounting rail acc. to EN 50 022

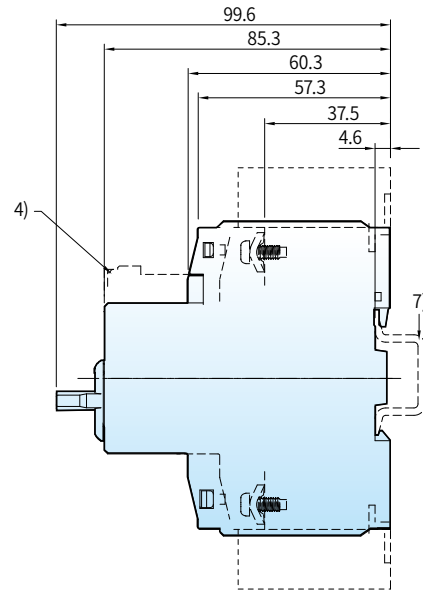
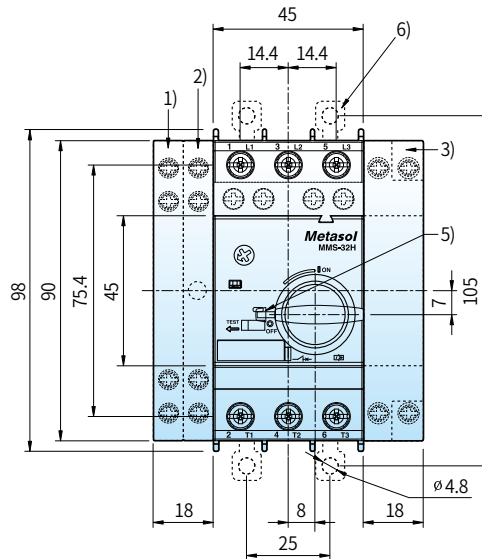

0.36kg

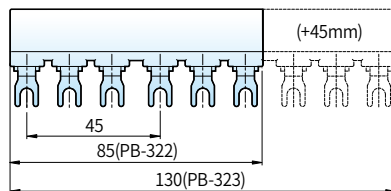
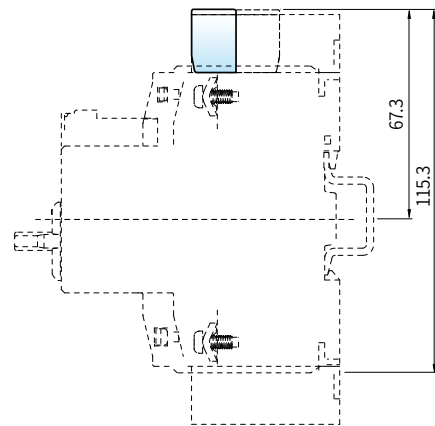
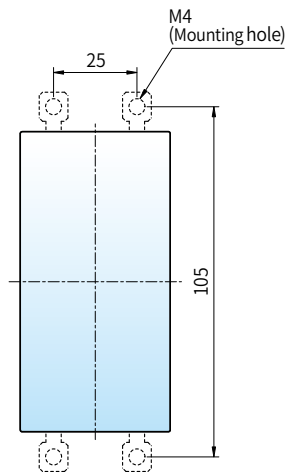

MMS-32H/32HI+PB-32  
PB-322 (2 Terminal), PB-323 (3 Terminal)  
PB-324 (4 Terminal), PB-325 (5 Terminal)

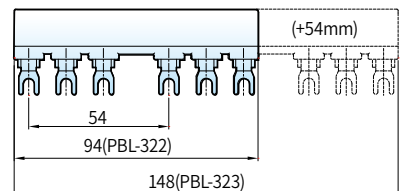

MMS-32H/32HI+PBL-32  
PBL-322(2 Terminal), PBL-323(3 Terminal)

# Dimension

## MMS

[mm]

### MMS-63S, 63H, 63HI

- 1) Side auxiliary switch
- 2) Side magnetic trip alarm switch
- 3) Side shunt release or side undervoltage release
- 4) Front auxiliary switch
- 5) Handle lock in Off position (Ø5mm)
- 6) 35mm standard mounting rail acc. to EN 50 022

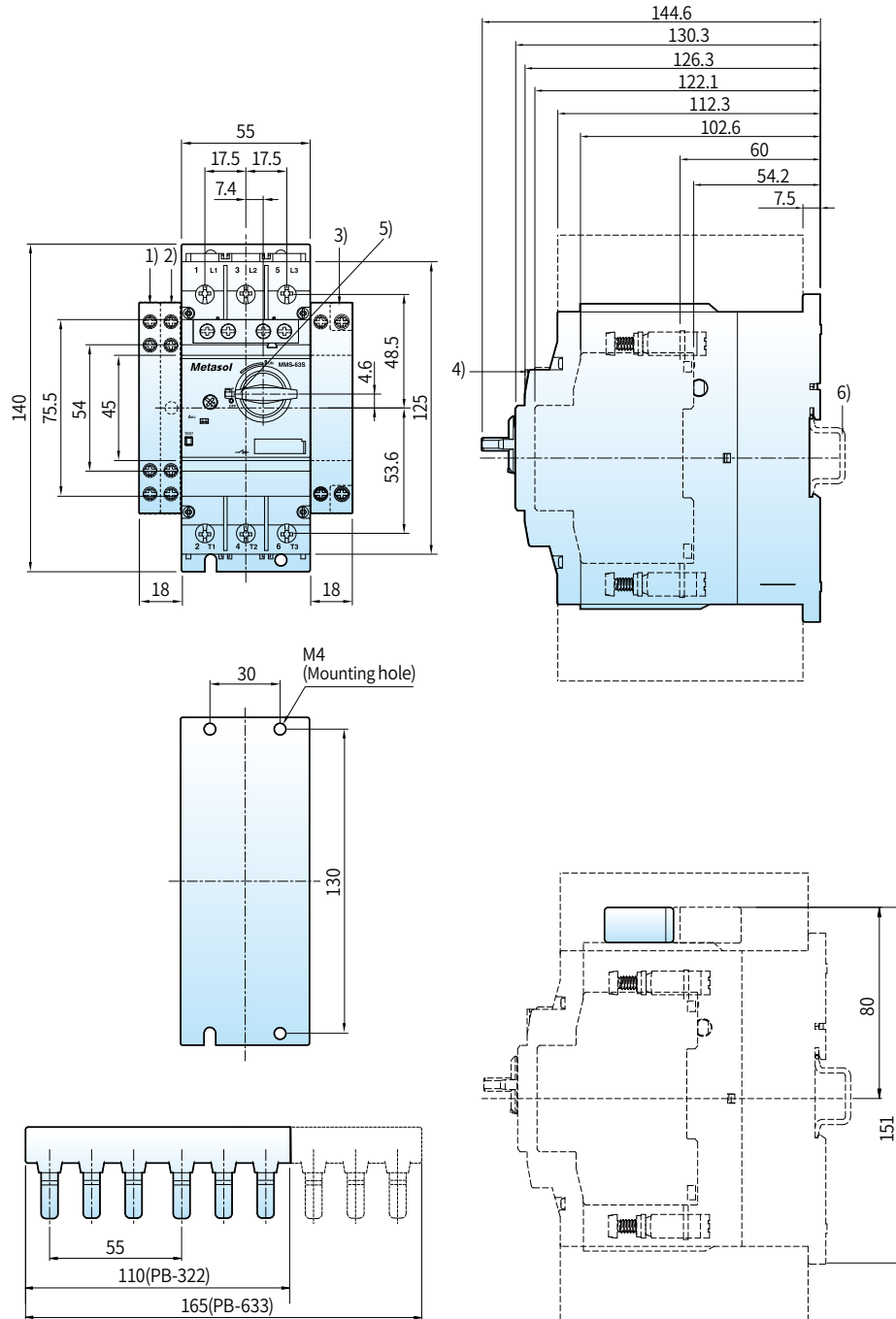

1kg

MMS-63S/H/HI+PB-63  
PB-632 (2 Terminal), PB-633 (3 Terminal)

[mm]

MMS-100S, 100H, 100HI

- 1) Side auxiliary switch
- 2) Side magnetic trip alarm switch
- 3) Side shunt release or side undervoltage release
- 4) Front auxiliary switch
- 5) Handle lock in Off position (Ø5mm)
- 6) 35mm standard mounting rail acc. to EN 50 022
- 7) 75mm standard mounting rail acc. to EN 50 023
- 8) 4mm hexagon socket screw

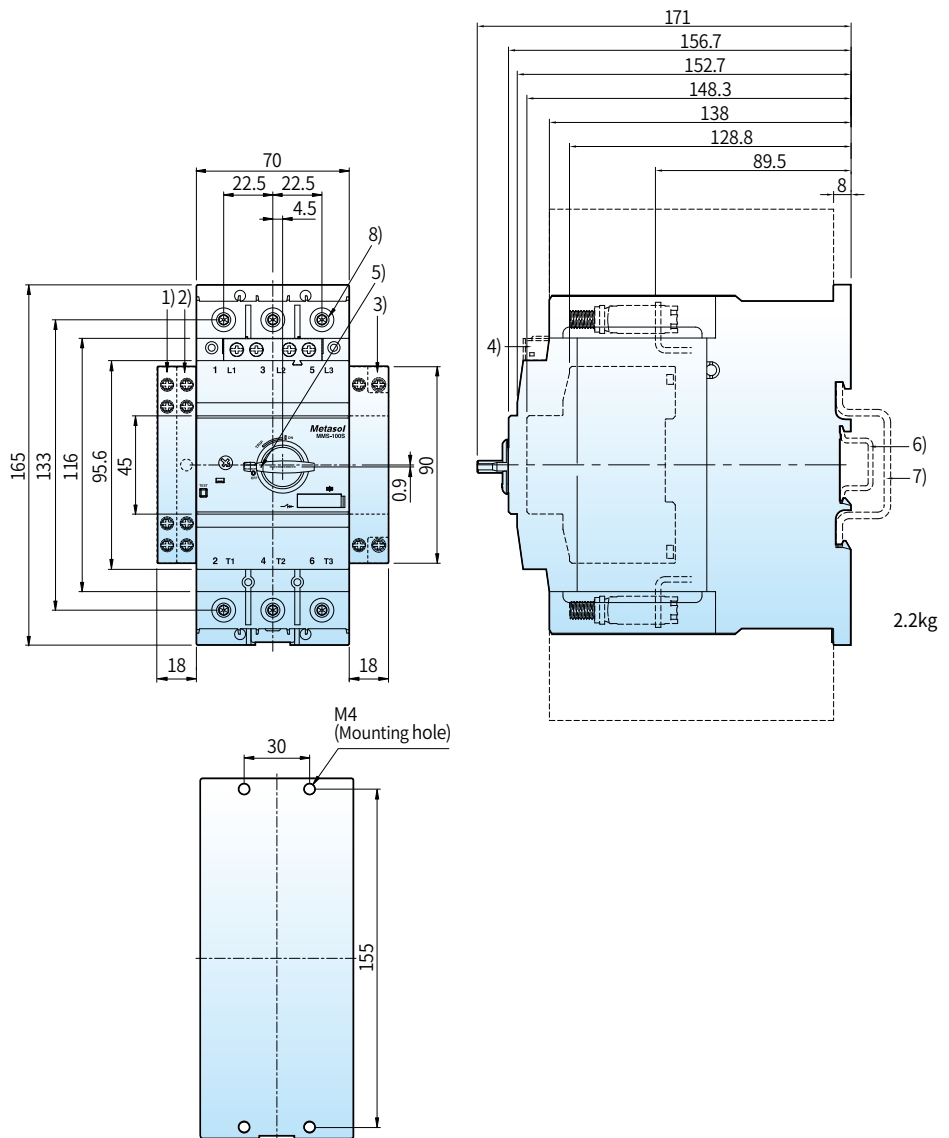

# Dimension

## MMS + Mini-MS

[mm]

**MMS-32S+**  
**GMC(D)-6M~16M**

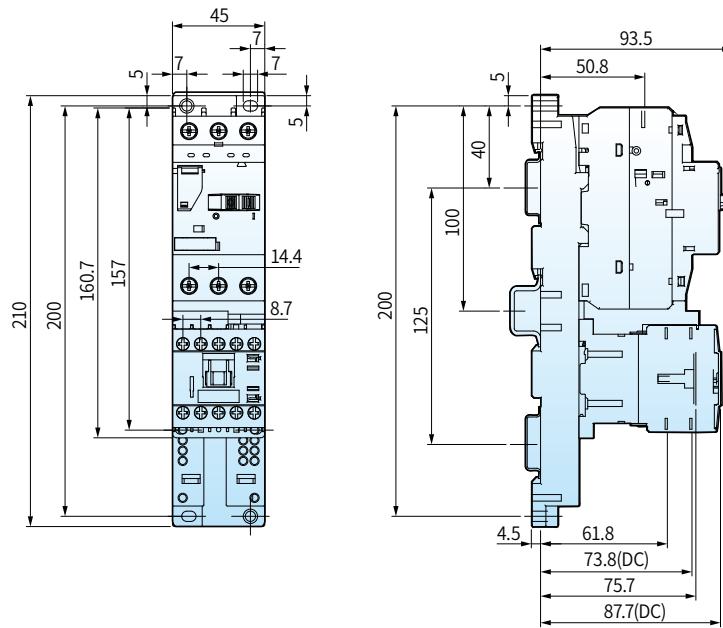

**MMS-32H+**  
**GMC(D)-6M~16M**

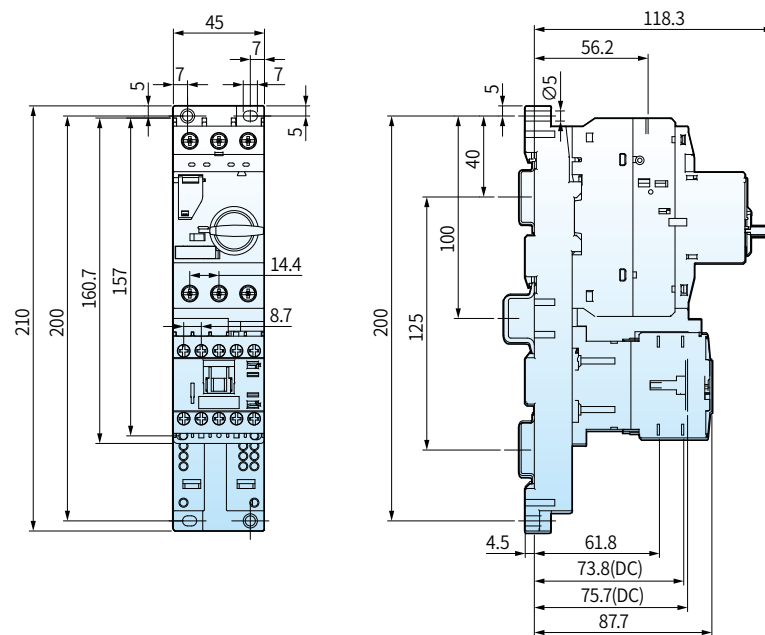



## MMS + Metasol MC

[mm]

MMS-32S+  
MC-6a~18a

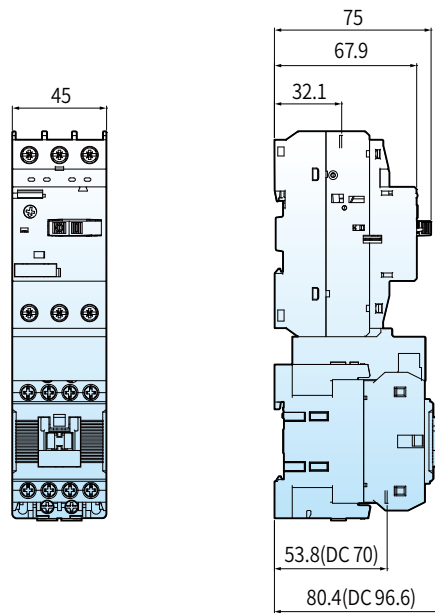

MMS-32S+  
MC-9b~22b

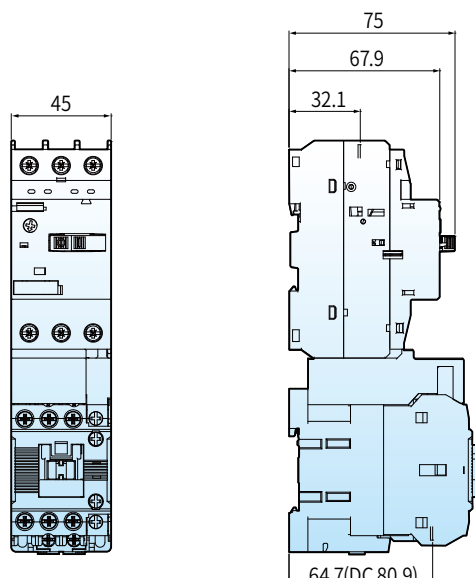

# Dimension

## MMS + Metasol MC

[mm]

### MMS-32S+MC-32a

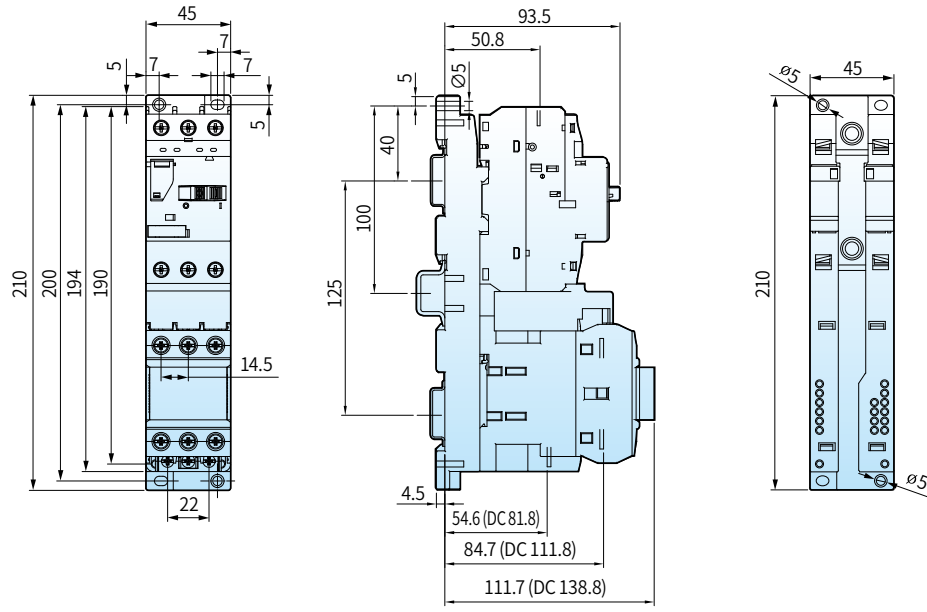

### MMS-32H, HI+MC-6a~18a

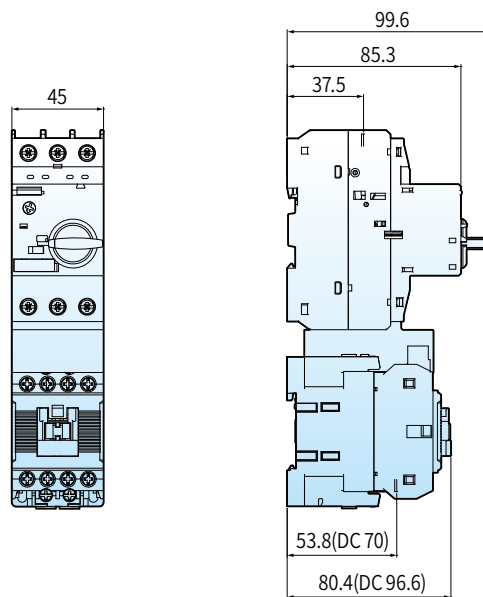

[mm]

MMS-32H,  
HI+MC-9b~22b

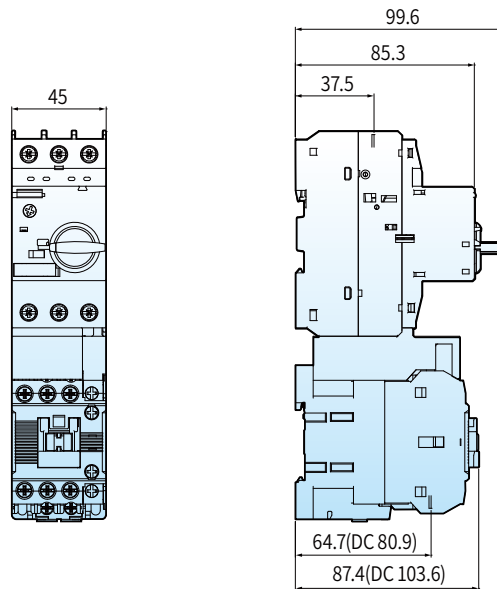

MMS-32H+MC-32a

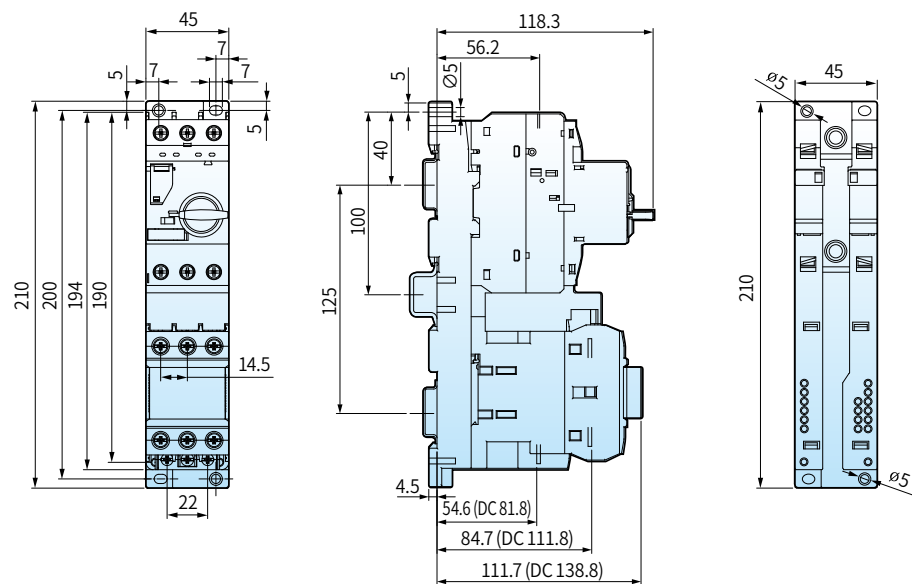

# Dimension

## MMS + Metasol MC

[mm]

### MMS-63H+MC-63a

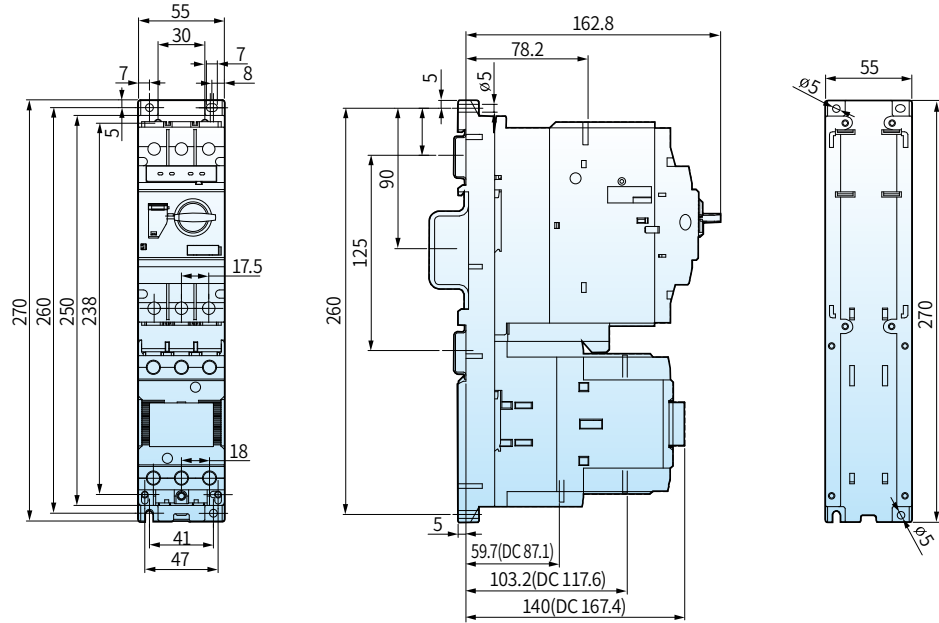

### MMS-100H+MC-100a

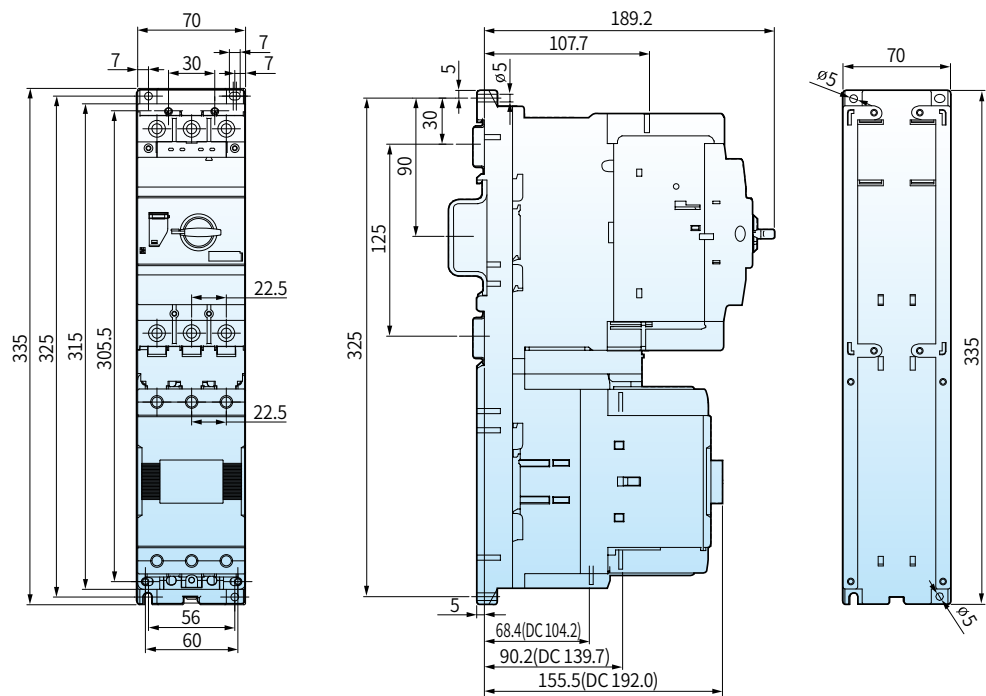

## External accessories

[mm]

### E-handle

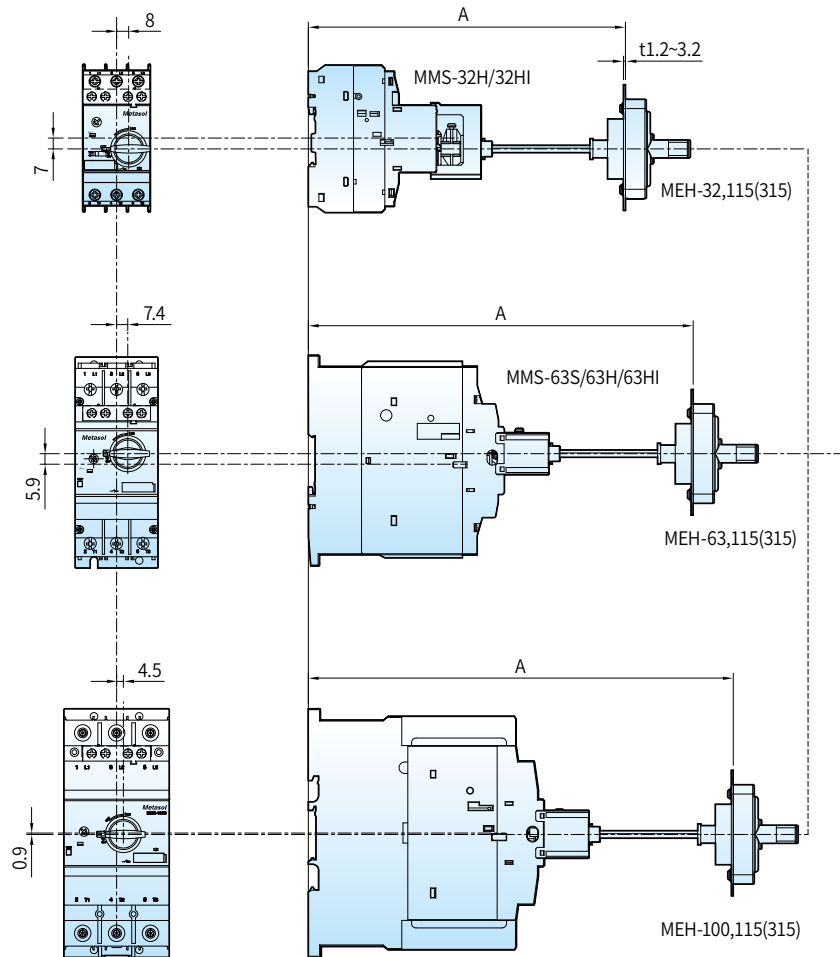

E-handle type	A(mm)	MMS type
MEH-32, 115	min : 148.6	MMS-32H/32HI
	max:210.6 (Shaft 115mm)	
MEH-32, 315	min : 148.6	
	max:410.6 (Shaft 315mm)	
MEH-63, 115	min : 193.6	MMS-63S/63H/63HI
	max:255.6 (Shaft 115mm)	
MEH-63, 315	min : 193.6	
	max:455.6 (Shaft 315mm)	
MEH-100, 115	min : 220	MMS-100S/100H/100HI
	max:282 (Shaft 115mm)	
MEH-100, 315	min : 220	
	max:482 (Shaft 315mm)	

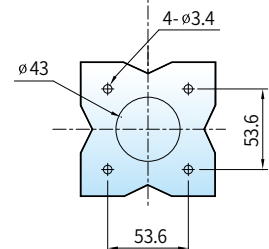

# Dimension

## External accessories

[mm]

### Enclosure

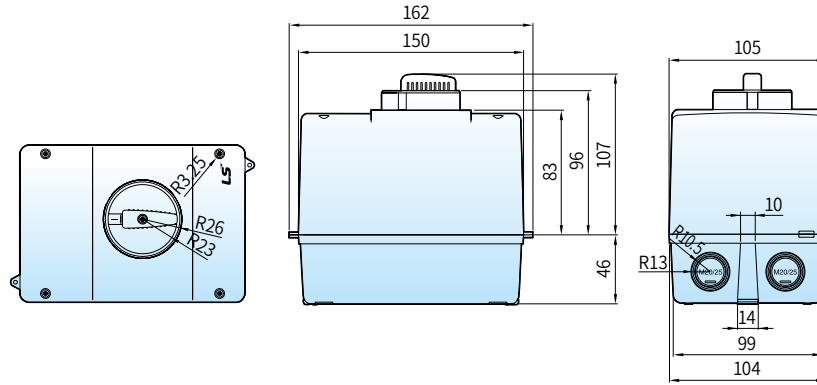

### Phase bus

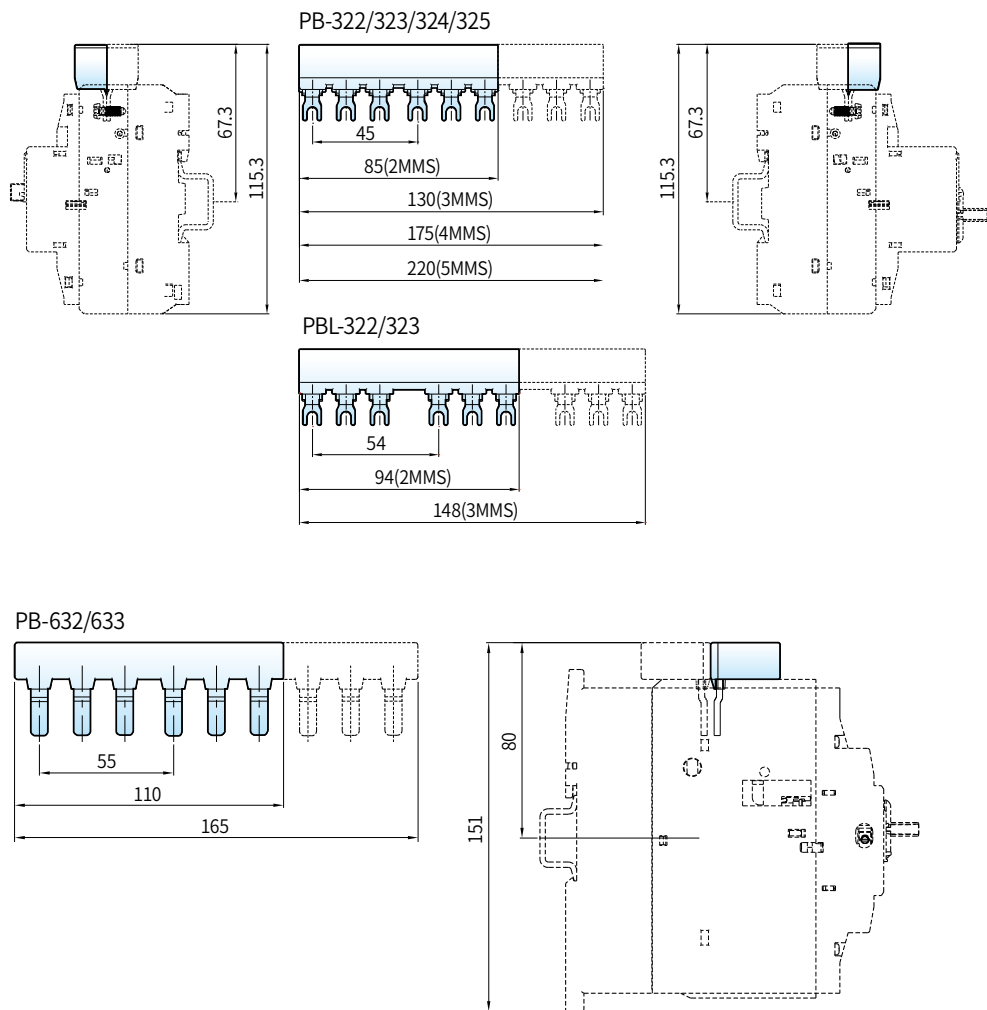

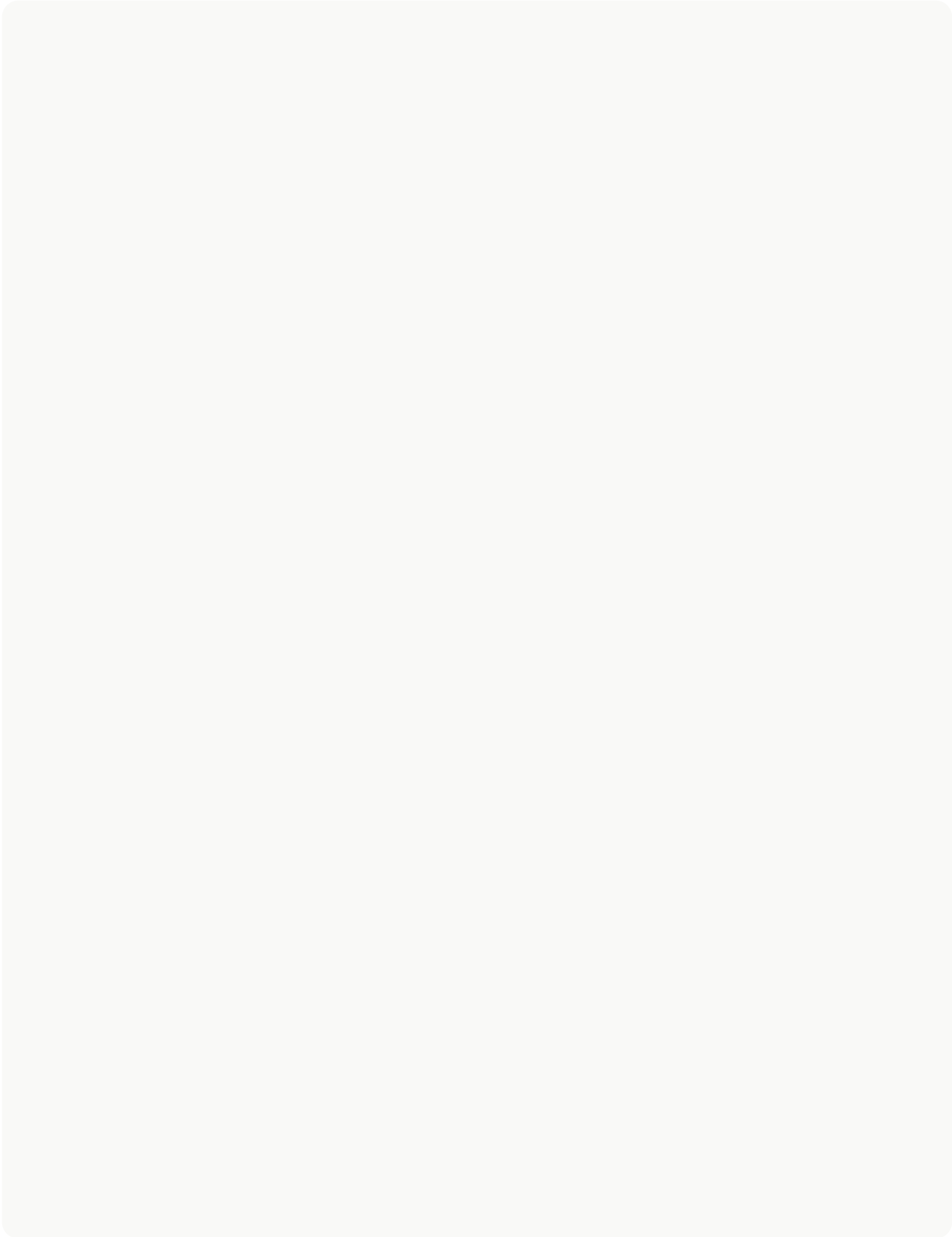



### Safety Instructions

- For your safety, please read user's manual thoroughly before operating.
- Contact the nearest authorized service facility for examination, repair, or adjustment.
- Please contact qualified service technician when you need maintenance. Do not disassemble or repair by yourself!
- Any maintenance and inspection shall be performed by the personnel having expertise concerned.



- According to The WEEE Directive, please do not discard the device with your household waste.



[www.ls-electric.com](http://www.ls-electric.com)

#### ■ Headquarter

LS-ro 127(Hogye-dong) Dongan-gu, Anyang-si, Gyeonggi-Do, 14119, Korea

#### ■ Seoul Office

LS Yongsan Tower, 92, Hangang-daero, Yongsan-gu, Seoul, 04386, Korea  
Tel: 82-2-2034-4916, 4684, 4429



#### Overseas Subsidiaries

- **LS ELECTRIC Japan Co., Ltd. (Tokyo, Japan)**  
Tel: 81-3-6268-8241 E-Mail: [japan@ls-electric.com](mailto:japan@ls-electric.com)
- **LS ELECTRIC (Dalian) Co., Ltd. (Dalian, China)**  
Tel: 86-411-8730-5872 E-Mail: [china.dalian@lselectric.com.cn](mailto:china.dalian@lselectric.com.cn)
- **LS ELECTRIC (Wuxi) Co., Ltd. (Wuxi, China)**  
Tel: 86-510-6851-6666 E-Mail: [china.wuxi@lselectric.com.cn](mailto:china.wuxi@lselectric.com.cn)
- **LS ELECTRIC Vietnam Co., Ltd. (Hanoi, Vietnam)**  
Tel: 84-222-22221-110 E-Mail: [vietnam@ls-electric.com](mailto:vietnam@ls-electric.com)
- **LS ELECTRIC Middle East FZE (Dubai, U.A.E.)**  
Tel: 971-4-886-5360 E-Mail: [middleeast@ls-electric.com](mailto:middleeast@ls-electric.com)
- **LS ELECTRIC Europe B.V. (Hoofddorp, Netherlands)**  
Tel: 31-20-654-1424 E-Mail: [europartner@ls-electric.com](mailto:europartner@ls-electric.com)
- **LS ELECTRIC America Inc. (Chicago, USA)**  
Tel: 1-800-891-2941 E-Mail: [sales.us@lselectricamerica.com](mailto:sales.us@lselectricamerica.com)
- **LS ENERGY Solutions LLC (Charlotte, USA)**  
Tel: 1-704-587-4051 E-Mail: [cmfeldman@ls-es.com](mailto:cmfeldman@ls-es.com)
- **LS ELECTRIC Türkiye Co., Ltd. (Istanbul, Türkiye)**  
Tel: 90-212-806-1252 E-Mail: [turkiye@ls-electric.com](mailto:turkiye@ls-electric.com)
- **LS ELECTRIC IBERIA S.L.U. (Madrid, Spain)**  
Tel: 34-910-28-02-74 E-Mail: [iberia@ls-electric.com](mailto:iberia@ls-electric.com)

#### ■ Overseas Branches

- **LS ELECTRIC Tokyo Office (Japan)**  
Tel: 81-3-6268-8241 E-Mail: [tokyo@ls-electric.com](mailto:tokyo@ls-electric.com)
- **LS ELECTRIC Beijing Office (China)**  
Tel: 86-10-5095-1631 E-Mail: [china@lselectric.com.cn](mailto:china@lselectric.com.cn)
- **LS ELECTRIC Shanghai Office (China)**  
Tel: 86-21-5237-9977 E-Mail: [china@lselectric.com.cn](mailto:china@lselectric.com.cn)
- **LS ELECTRIC Guangzhou Office (China)**  
Tel: 86-20-3818-2883 E-Mail: [china@lselectric.com.cn](mailto:china@lselectric.com.cn)
- **LS ELECTRIC Chengdu Office (China)**  
Tel: 86-28-8670-3201 E-Mail: [china@lselectric.com.cn](mailto:china@lselectric.com.cn)
- **LS ELECTRIC Qingdao Office (China)**  
Tel: 86-532-8501-2065 E-Mail: [china@lselectric.com.cn](mailto:china@lselectric.com.cn)
- **LS ELECTRIC Nanjing Office (China)**  
Tel: 86-25-8467-0005 E-Mail: [china@lselectric.com.cn](mailto:china@lselectric.com.cn)
- **LS ELECTRIC Bangkok Office (Thailand)**  
Tel: 66-90-950-9683 E-Mail: [thailand@ls-electric.com](mailto:thailand@ls-electric.com)
- **LS ELECTRIC Jakarta Office (Indonesia)**  
Tel: 62-21-2933-7614 E-Mail: [indonesia@ls-electric.com](mailto:indonesia@ls-electric.com)
- **LS ELECTRIC Moscow Office (Russia)**  
Tel: 7-499-682-6130 E-Mail: [info@lselectric-ru.com](mailto:info@lselectric-ru.com)
- **LS ELECTRIC America Western Office (Irvine, USA)**  
Tel: 1-949-333-3140 E-Mail: [america@ls-electric.com](mailto:america@ls-electric.com)
- **LS ELECTRIC India Office (India)**  
Tel: 91-80-6142-9108 E-Mail: [Info\\_india@ls-electric.com](mailto:Info_india@ls-electric.com)
- **LS ELECTRIC Singapore Office (Singapore)**  
Tel: 65-6958-8162 E-Mail: [singapore@ls-electric.com](mailto:singapore@ls-electric.com)
- **LS ELECTRIC Italy office (Italy)**  
Tel: 39-030-8081-833 E-Mail: [italia@ls-electric.com](mailto:italia@ls-electric.com)