

Zelio Control

RTC48 Temperature Controller User Guide

04/2013

E10000001539.00

www.schneider-electric.com

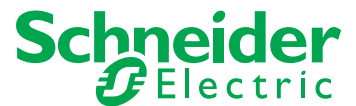

The information provided in this documentation contains general descriptions and/or technical characteristics of the performance of the products contained herein. This documentation is not intended as a substitute for and is not to be used for determining suitability or reliability of these products for specific user applications. It is the duty of any such user or integrator to perform the appropriate and complete risk analysis, evaluation and testing of the products with respect to the relevant specific application or use thereof. Neither Schneider Electric nor any of its affiliates or subsidiaries shall be responsible or liable for misuse of the information that is contained herein. If you have any suggestions for improvements or amendments or have found errors in this publication, please notify us.

No part of this document may be reproduced in any form or by any means, electronic or mechanical, including photocopying, without express written permission of Schneider Electric.

All pertinent state, regional, and local safety regulations must be observed when installing and using this product. For reasons of safety and to help ensure compliance with documented system data, only the manufacturer should perform repairs to components.

When devices are used for applications with technical safety requirements, the relevant instructions must be followed.

Failure to use Schneider Electric software or approved software with our hardware products may result in injury, harm, or improper operating results.

Failure to observe this information can result in injury or equipment damage.

© 2013 Schneider Electric. All rights reserved.

Table of Contents



	Safety Information	5
	About the Book	7
Part I	RTC48 Temperature Controller	9
Chapter 1	Introduction	11
	Display and Controller References of RTC48	12
	Main Specifications	15
Chapter 2	Hardware of RTC48	17
	Electrical and Environmental Characteristics	18
	Dimensions and Installation of RTC48	20
	Wiring of RTC48	24
Chapter 3	Configuration of RTC48	29
	How to Configure Using Front Panel	30
	Basic Operations	31
	Lock	32
	Setting the Temperature Controller	33
	Operation Flowchart	37
	Parameters List	40
Chapter 4	Main Functions of RTC48	53
	Auto-Tuning	54
	Control Actions	57
	Alarm Functions	58
	PV Color Display Function	60
	OUT1 Rate of Change	62
Part II	Appendices	63
Chapter 5	RTC48 Error Messages	65
	Troubleshooting	65
Index	69

Safety Information

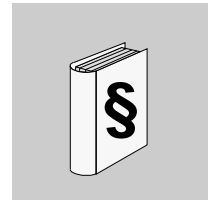

Important Information

NOTICE

Read these instructions carefully, and look at the equipment to become familiar with the device before trying to install, operate, or maintain it. The following special messages may appear throughout this documentation or on the equipment to warn of potential hazards or to call attention to information that clarifies or simplifies a procedure.



The addition of this symbol to a Danger safety label indicates that an electrical hazard exists, which will result in personal injury if the instructions are not followed.



This is the safety alert symbol. It is used to alert you to potential personal injury hazards. Obey all safety messages that follow this symbol to avoid possible injury or death.

DANGER

DANGER indicates an imminently hazardous situation which, if not avoided, **will result in** death or serious injury.

WARNING

WARNING indicates a potentially hazardous situation which, if not avoided, **can result in** death or serious injury.

 **CAUTION**

CAUTION indicates a potentially hazardous situation which, if not avoided, **can result in** minor or moderate injury.

NOTICE

NOTICE is used to address practices not related to physical injury.

PLEASE NOTE

Electrical equipment should be installed, operated, serviced, and maintained only by qualified personnel. No responsibility is assumed by Schneider Electric for any consequences arising out of the use of this material.

A qualified person is one who has skills and knowledge related to the construction and operation of electrical equipment and its installation, and has received safety training to recognize and avoid the hazards involved.

About the Book

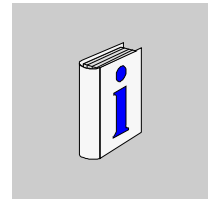

At a Glance

Document Scope

This guide describes the RTC48 temperature controller.

It provides the following of the RTC48 temperature controller:

- Main characteristics,
- Installation,
- Wiring,
- Configuration,
- Main functions, and so on.

Validity Note

This document is valid for the RTC48 temperature controller.

Registered Trademarks

Microsoft® and Windows® are registered trademarks of Microsoft Corporation.

Related Documents

Title of Documentation	Reference Number
RTC48 Temperature Controller Quick Start Guide	HRB3156801 (Eng) HRB7904900 (Fre) HRB7905100 (Chs) HRB7905200 (Ger) HRB7905400 (Ita) HRB7905600 (Spa)
RTC48 Communication and Zelio Temperature Control Soft User Guide	EIO0000001545 (Eng) EIO0000001546 (Fre) EIO0000001547 (Gre) EIO0000001548 (Spa) EIO0000001549 (Ita) EIO0000001550 (Chs)

You can download these technical publications and other technical information from our website at www.schneider-electric.com.

User Comments

We welcome your comments about this document. You can reach us by e-mail at techcomm@schneider-electric.com.

RTC48 Temperature Controller

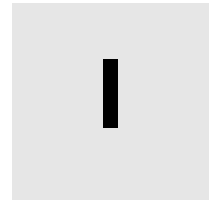

What Is in This Part?

This part contains the following chapters:

Chapter	Chapter Name	Page
1	Introduction	11
2	Hardware of RTC48	17
3	Configuration of RTC48	29
4	Main Functions of RTC48	53

Introduction



1

What Is in This Chapter?

This chapter contains the following topics:

Topic	Page
Display and Controller References of RTC48	12
Main Specifications	15

Display and Controller References of RTC48

Display of RTC48

The RTC48 is the temperature controller. It can be used in stand-alone installation for simple machine or more complex system in association with programmable logic controller (PLC), Human Machine Interface (HMI) through communication Modbus (RS485).

The front panel has the Process Value (PV) and Setpoint Value (SV) displays and indicators, the action indicators, and the setting keys.

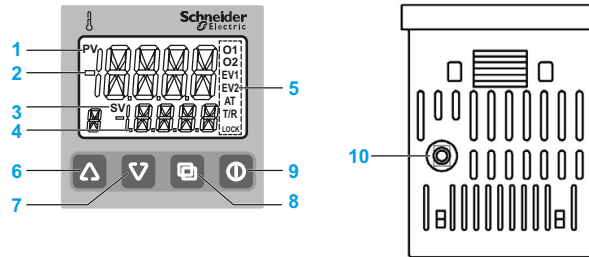

Item	Name	Function
1	PV indicator	Lights when Process Values (PV) are indicated in the PV/SV display mode.
2	PV display	Indicates the PV or displays the name of the parameters during the setting mode.
3	SV indicator	Lights when Setting Values (SV) are indicated in the PV/SV display mode.
4	SV display	Indicates the SV, Manipulated Variable (MV), or each set value during the setting mode.
5	Action indicators	O1 (OUT1): Lights when control output (OUT1) is ON. O2 (OUT2): Lights when control output (OUT2) (when OUT2 model applicable) is ON. EV1: Lights when Alarm 1 output is ON. EV2: Lights when Alarm 2 output is ON (when Alarm 2 model is applicable). AT: Flashes while auto-tuning (AT) or auto-reset is performing. T/R: Lights during serial communication (when communication model is applicable). LOCK: Lights when Lock 1, Lock 2, or Lock 3 is selected.
6	Increase key	Increases the numeric value.

Item	Name	Function
7	Decrease key	Decreases the numeric value.
8	Page key	Selects the setting mode or registers the setting value. To register the SV, press this key.
9	OUT/OFF key	Switches control output ON/OFF or Auto/Manual control.
10	Console connector	By connecting to the USB communication cable (RTCCBL, sold separately), you can conduct the following operations from an external computer using the loader software Zelio Temperature Control Soft: <ul style="list-style-type: none"> ● Reading and setting of SV, PID, and various set values ● Reading of PV and action status ● Function change ● Monitoring the trend of PV, SV, and MV

Controller References and Characteristics

This table shows the controller references with the characteristics of each:

Part Number	Power Supply	Input	Output 1	Output 2	Modbus	Alarm = 1 (for Alarm 1) = 2 (for Alarm 1 + 2)
RTC48PUN1RNHU	110...240 Vac	Universal input	Relay	–	–	1
RTC48PUN1SNHU			SSR	–	–	1
RTC48PUNCRNHU			Relay	–	RS485	1
RTC48PUNCSNHU			SSR	–	RS485	1
RTC48PUN1RRHU			Relay	Relay	–	1
RTC48PUN1SRHU			SSR	Relay	–	1
RTC48PUN2RNHU			Relay	–	–	2
RTC48PUN2SNHU			SSR	–	–	2
RTC48PUNCRRHU			Relay	Relay	RS485	1
RTC48PUNCSRHU			SSR	Relay	RS485	1
RTC48PUN1RSHU			Relay	SSR	–	1
RTC48PUN1SSHU			SSR	SSR	–	1
RTC48PUNCRSHU			Relay	SSR	RS485	1
RTC48PUNCSSHU			SSR	SSR	RS485	1

Part Number	Power Supply	Input	Output 1	Output 2	Modbus	Alarm = 1 (for Alarm 1) = 2 (for Alarm 1 + 2)
RTC48PUN1RNLU	24 Vac/dc	Universal input	Relay	–	–	1
RTC48PUN1SNLU			SSR	–	–	1
RTC48PUNCRNLU			Relay	–	RS485	1
RTC48PUNCSNLU			SSR	–	RS485	1
RTC48PUN1RRLU			Relay	Relay	–	1
RTC48PUN1SRLU			SSR	Relay	–	1
RTC48PUN2RNLU			Relay	–	–	2
RTC48PUN2SNLU			SSR	–	–	2
RTC48PUNCRRLU			Relay	Relay	RS485	1
RTC48PUNCSRLU			SSR	Relay	RS485	1
RTC48PUN1RSLU			Relay	SSR	–	1
RTC48PUN1SSLU			SSR	SSR	–	1
RTC48PUNCRSLU			Relay	SSR	RS485	1
RTC48PUNCSSLU			SSR	SSR	RS485	1

Accessories

This table shows the accessories:

Item	Description	Quantity
Included	RTC48 Temperature Controller Quick Start Guide	1 copy
	Mounting frame	1 piece
	Gasket (Front mounted to the RTC48)	1 piece
	50 Ω shunt resistor (DC current input)	1 piece
Sold separately	Terminal cover (RTCCOV)	2 pieces
	Communication cable (RTCCBL)	1 piece
	Spare parts (RTCACC): <ul style="list-style-type: none"> ● Terminal cover: 1 piece ● 50 Ω shunt resistor: 1 piece ● Mounting frame: 1 piece 	1 set
PC software	Zelio Temperature Control Soft V1 NOTE: You can download the PC software from www.schneider-electric.com	1

Main Specifications

Overview

This table presents the main specifications of RTC48:

Characteristics	Values
Display	PV display 11-segment red/green/orange backlight LCD Character size: 12.0 x 5.0 mm (0.47 x 0.20 in.) (H x W)
	SV display 11-segment green backlight LCD Character size: 6.0 x 3.5 mm (0.24 x 0.14 in.) (H x W)
	Action indicators: orange backlight
Buttons	4 (Increase, Decrease, Page, and OUT/OFF)
Power supply	<ul style="list-style-type: none"> ● 100...240 Vac ● 24 Vac ● 24 Vdc
Input	<ul style="list-style-type: none"> ● Thermocouple ● RTD: Pt100, JPt100, 3-wire system ● DC current: 0...20 mA DC, 4...20 mA DC ● DC voltage: 0...1 Vdc, 0...5 Vdc, 1...5 Vdc, and 0...10 Vdc
Sampling period	250 ms
Communication	RS485 Modbus (2400 up to 19200 bauds)
Output	<ul style="list-style-type: none"> ● 2 outputs ● Electromechanical relay ● Solid state relay
Alarm	2 (Alarm 1 and Alarm 2)
Weight	Approximately 120 g (4.23 oz)
External dimensions	48 x 48 x 62 mm (1.89 x 1.89 x 2.44 in.)(W x H x D)
Color	Grey (case)
Drip-proof/Dust-proof	IP66
PC software	Zelio Temperature Control Soft V1

Hardware of RTC48



2

What Is in This Chapter?

This chapter contains the following topics:

Topic	Page
Electrical and Environmental Characteristics	18
Dimensions and Installation of RTC48	20
Wiring of RTC48	24

Electrical and Environmental Characteristics

Electrical Characteristics of RTC48

This table presents the electrical characteristics:

Specifications	Values
Power supply	<ul style="list-style-type: none"> ● 100 Vac (-15%) to 240 Vac (+10%) ● 24 Vac/Vdc (+10%) ● 50/60 Hz
Power Consumption	Approximately 8 VA
Process Value input	Input accuracy for Thermocouple: <ul style="list-style-type: none"> ● Within $\pm 0.2\%$ of each input span ± 1 digit, or within $\pm 2\text{ }^{\circ}\text{C}$ ($4\text{ }^{\circ}\text{F}$), whichever is greater ● R, S input, $0\text{...}200\text{ }^{\circ}\text{C}$ ($0\text{...}400\text{ }^{\circ}\text{F}$): Within $\pm 6\text{ }^{\circ}\text{C}$ ($12\text{ }^{\circ}\text{F}$) ● B input, $0\text{...}300\text{ }^{\circ}\text{C}$ ($0\text{...}600\text{ }^{\circ}\text{F}$): Accuracy is not guaranteed ● K, J, E, T, N input, less than $0\text{ }^{\circ}\text{C}$ ($32\text{ }^{\circ}\text{F}$): Within $\pm 0.4\%$ of input span ± 1 digit
	RTD: Within $\pm 0.1\%$ of each input span ± 1 digit, or within $\pm 1\text{ }^{\circ}\text{C}$ ($2\text{ }^{\circ}\text{F}$), whichever is greater
	DC current, voltage: Within $\pm 0.2\%$ of each input span ± 1 digit
Control output	Relay contact: <ul style="list-style-type: none"> ● Control capacity: 3 A, 250 Vac (resistive load) 1 A, 250 Vac (inductive load $\cos\phi = 0.4$), Electrical life: 100,000 cycles Non-contact voltage (for SSR drive): 12 Vdc $\pm 15\%$, Max. 40 mA DC (short circuit protected)
Communication function	<ul style="list-style-type: none"> ● Transmission method: Half-duplex bit serial communication ● Transmission rate: 2400/4800/9600/19200 bps ● Transmission protocol: Modbus ASCII/Modbus RTU ● Transmission distance: Maximum 1.2 km (Total length) ● Connectable units: Maximum 31 units to 1 host computer

NOTE: Connect a 50 Ω shunt resistor when using DC current input. Refer to the Wiring topic (*see page 24*) for more information.

Environmental Characteristics of RTC48

The following table presents the environmental characteristics:

Characteristics	Values
Operating ambient temperature	0...50 °C (32...122 °F)
Operating ambient humidity	35...85 % RH
Storage temperature	-25...80 °C (-13...176 °F)
Installation category	II (conforming to IEC 61010-1)
Pollution degree	2 (conforming to IEC 61010-1)
Conforming to standard	LVD EN61010-1, EMC EN61326-1
Product certification	UR (UL873), CSA C22.2 No 24-93. CU- EAC

Dimensions and Installation of RTC48

Installation Precautions

WARNING

UNINTENDED EQUIPMENT OPERATION

Do not install the controller where:

- Ambient temperature is outside the range of 0...50 °C (32...122 °F) while in operation.
- Ambient humidity is more than 85 % RH while in operation.
- Condensation can occur.
- Corrosive or combustible gases are present.
- There is vibration or shock higher than the specified value.
- Exposure to water oil, chemicals, steam, or vapor.
- Exposure to dust, salty air, or air containing high concentrations of metal particles.
- Subject to electromagnetic interference from static electricity, magnetism, and external electromagnetic interference sources.
- Exposure to direct sunshine.
- Heat accumulation due to solar radiation.

Failure to follow these instructions can result in death, serious injury, or equipment damage.

WARNING

UNINTENDED EQUIPMENT OPERATION

Do not allow the openings around the controller to be blocked, heat dissipation ability will be reduced.

Do not allow the ventilation openings on top of the terminal block to be blocked.

Failure to follow these instructions can result in death, serious injury, or equipment damage.

NOTE: The front side of this controller conforms to NEMA 4X.

Dimensions of Controller

The following figure shows the external dimensions:

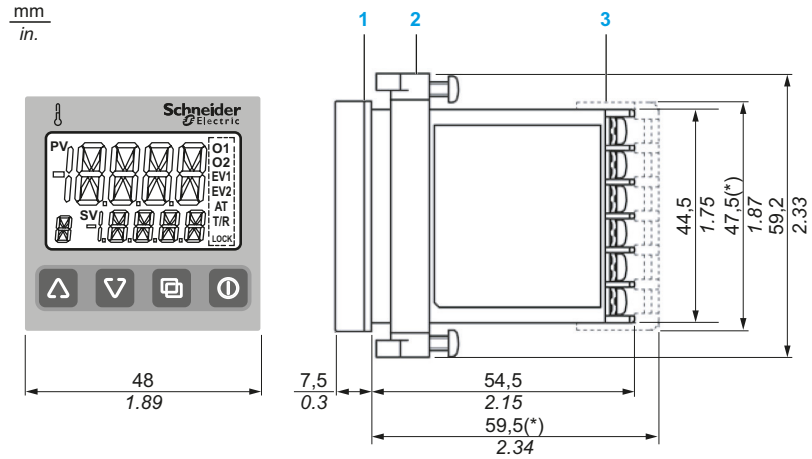

- 1 Gasket
- 2 Mounting frame
- 3 RTCCOV terminal cover (sold separately)

Panel Cut-out

⚠ CAUTION

UNINTENDED EQUIPMENT OPERATION

To ensure protection against dust and water (IP66):

- Use the appropriate panel cut out.
- Use the appropriate gasket and panel mounting adapter provided.
- Assemble the product according to installation guide.

Failure to follow these instructions can result in injury or equipment damage.

Panel cut-out dimensions for separate mounting:

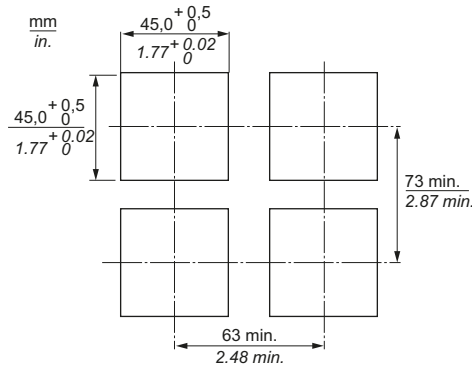

Panel cut-out dimensions for mounting close together:

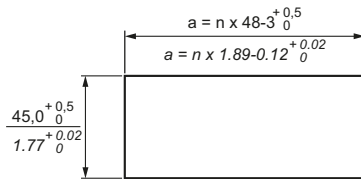

Value of a:

Number of Units: n	2	3	4	5	6
a (mm)	93	141	189	237	285
a (in.)	3.66	5.55	7.44	9.33	11.22

NOTE:

- The IP66 specification (Water proof/Dust proof) may be compromised and all warranties will be invalid.
- Maximum ambient temperature is 45 °C (113 °F) if mounted close together.

Mounting the RTC48

Mount the controller vertically to the flat, rigid panel to ensure it adheres to the Drip-proof/Dust-proof specification (IP66). Mountable panel thickness: 1...5 mm (0.04...0.20 in.).

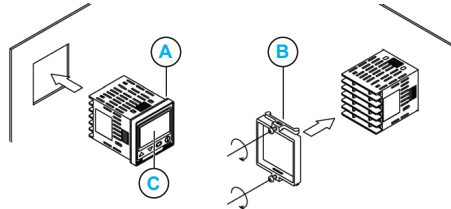

Follow the steps given below when mounting the controller:

Step	Action
1	Insert the controller from the front side of the panel, using the gasket (A).
2	Insert the mounting frame (B) until it comes into contact with the panel and fasten with the screw. Tighten screws with one rotation upon the screw tips touching the panel. The torque is 0.05...06 N•m.
3	Remove the transparent protective screen sheet (C) before you start to use.

Dismounting the RTC48

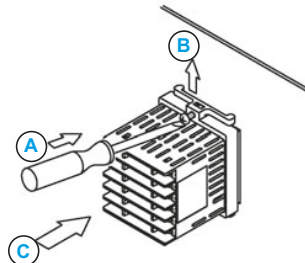

Follow the steps given below when dismantling the controller:

Step	Action
1	Turn the power to the unit OFF, and disconnect all wires before removing the mounting frame.
2	Insert a flat blade screwdriver between the screw frame and unit.
3	Slowly, push the frame upward using the screwdriver while pushing the unit toward the panel.
4	Repeat step (B) and slowly push the frame downward using the screwdriver for the other side. You can remove the frame little by little by repeating these steps.

Wiring of RTC48

Overview

DANGER

HAZARD OF ELECTRIC SHOCK, EXPLOSION, OR ARC FLASH

- Disconnect all power from the controller.
- Always use a properly rated voltage sensing device to confirm power is off.
- Use only the specified voltage when operating the controller.

Failure to follow these instructions will result in death or serious injury.

CAUTION

UNINTENDED EQUIPMENT OPERATION

To ensure protection against dust and water (IP66):

- The terminal block of this instrument is designed to be wired from the left side. The lead wire must be inserted from the left side of the terminal and fastened with the terminal screw. The torque must be 0.63 N•m (5.57 lb-in).
- This instrument does not have a built-in power switch, circuit breaker, or fuse. It is necessary to install them near the controller. (Recommended fuse: Time-lag fuse, rated voltage 250 Vac, rated current 2 A).
- For a 24 Vac/dc power source, do not confuse polarity when using direct current (DC).
- Use a thermocouple and compensating lead wire according to the sensor input specifications of this controller.
- Use the 3-wire RTD according to the sensor input specifications of this controller.
- (+) side input terminal number of 0...5 Vdc, 1...5 Vdc, 0...10 Vdc differs from that of 0...1 Vdc.
(+) side input terminal number of 0...5 Vdc, 1...5 Vdc, 0...10 Vdc: 9.
(+) side input terminal number of 0...1 Vdc: 10.
- When using a relay contact output type, externally use a relay according to the capacity of the load to protect the built-in relay contact.
- When wiring, keep input wires (thermocouple, RTD, and so on.) away from AC sources or load wires to avoid external interference.

Failure to follow these instructions can result in injury or equipment damage.

Wiring of the RTC48

The following figure displays the wiring of the RTC48 controllers:

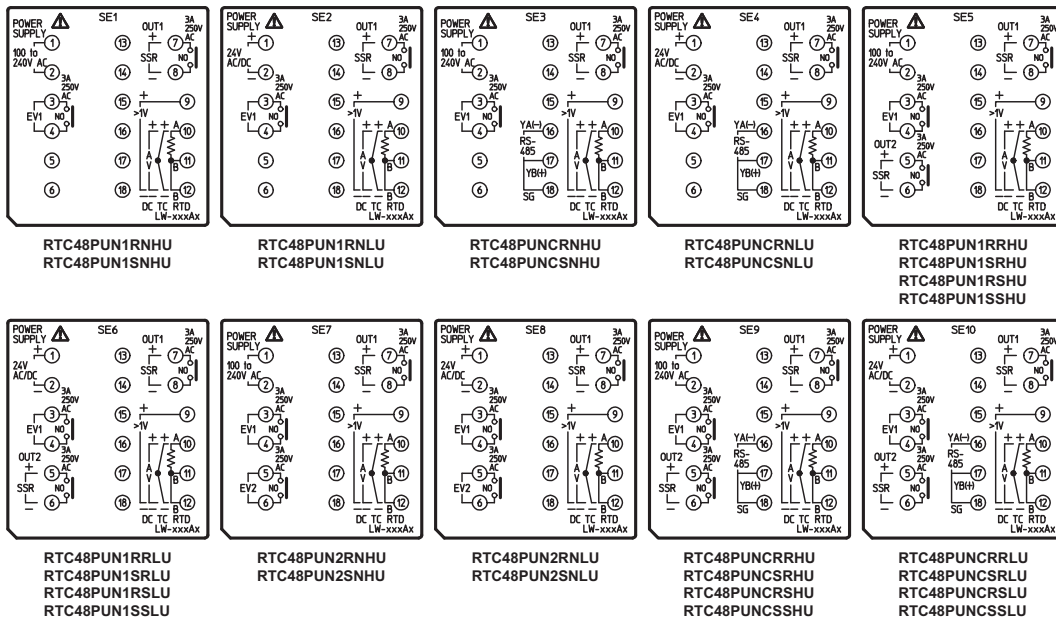

This table provides the description for the symbols:

Symbols	Description
Power Supply	For a 24 Vac/dc power source, do not confuse polarity when using direct current (DC)
EV1	Alarm 1 output
EV2	Alarm 2 output (A2 option), or heater burnout alarm output (W, W3 option)
OUT2	Control output 2 (OUT2), either relay output or SSR output
OUT1	Control output 1 (OUT1), either relay output or SSR output
DC	DC current, DC voltage input (For DC voltage input, + side terminal number differs depending on the voltage input.) For DC current input, connect 50 Ω shunt resistor externally.
TC	Thermocouple input
RTD	Resistance temperature detector input such as PT100, JPT100
RS485	Serial communication
SSR	Solid-State Relay

Designation of Wiring Material

NOTE:

- Do not use wire other than the one stated below.
- Be sure to insert wire toward the recess of the terminal block.
- The recommended torque is 0.63 N•m (5.57 lb-in).

Wire:

- (1): Gauge: AWG28 (0.1 mm²) to AWG16 (1.25 mm²).
- (2): Strip-off length: 5...6 mm (0.20...0.24 in.).

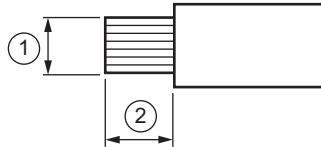

Rod terminal:

- (3) (4): Dimension of exposed conductor section: 2 x 1.5 mm (0.08 x 0.06 in.) or smaller.
- (5): Length of exposed conductor section: 5...6 mm (0.2...0.24 in.).

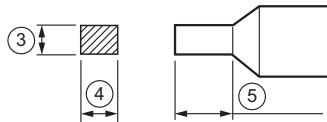

Lead Wire Solderless Terminal

Use a solderless terminal with an insulation sleeve in which an M3 screw fits as shown below.

The torque must be 0.63 N•m (5.57 lb-in).

Solderless Terminal	Model	Tightening Torque
Y type	TMEV1.25Y-3	0.63 N•m (5.57 lb-in)
	VD1.25-B3A	
Ring type	TMEV 1.25-3	
	V1.25-3	

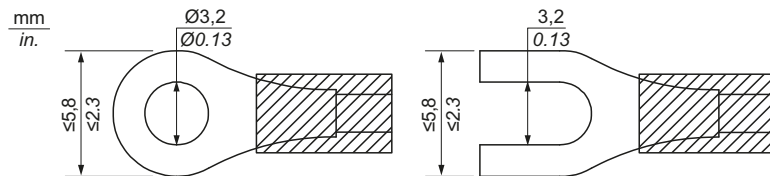

RTCCOV Terminal Cover

When using a RTCCOV terminal cover (sold separately), pass terminal wires numbered 7 to 12 into the holes of the terminal cover.

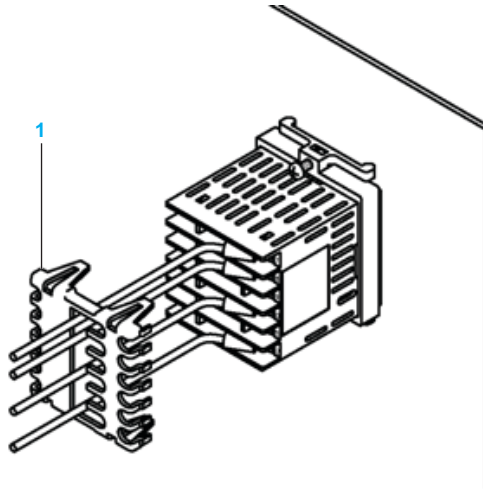

1 RTCCOV terminal cover

Configuration of RTC48

3

What Is in This Chapter?

This chapter contains the following topics:

Topic	Page
How to Configure Using Front Panel	30
Basic Operations	31
Lock	32
Setting the Temperature Controller	33
Operation Flowchart	37
Parameters List	40

How to Configure Using Front Panel

Overview



After the power is turned on, the controller starts in automatic control mode. This is the regular mode of operation where PV and SV values are displayed.

The PV display indicates the input type and the SV display indicates Input range high limit value (TC, RTD) or Scaling high limit value (DC voltage, DC current).

To configure the module, you can use the keys on the front panel or configure using PC software. For more information, refer to the RTC48 Communication and Zelio Temperature Control Soft User Guide (*see page 8*).

NOTE: Some parameters are not displayed on the panel depending on different models or masking the parameters in purpose or depending on the selection of `LoCK` for modifiable parameters.

Changing the Modes

Press the  key, the  key, or the  key or the combination of these keys switches between 4 modes. The 4 modes are Main setting mode, Sub setting mode, Auxiliary function setting mode, and Setup mode.







For more details, refer to the Parameters list (*see page 40*).

Basic Operations

Changing SV (Set Values)











After the power is turned on to the display unit, the display unit displays the PV/SV display mode.

To set the SV to 100 °C (212 °F), proceed as follows:

Step	Description	Remarks
1	Press the  key in the PV/SV display mode.	The display unit proceeds to Main Setting mode. 
2	Use the  ,  keys to set the SV.	– 
3	Press the  key to register the SV.	The display unit reverts to the PV/SV display mode. 
4	The control starts so as to keep measuring the temperature at 100 °C (212 °F).	–

Switching Auto/Manual Control

To select the Auto/Manual Control, proceed as follows:

Step	Description	Remarks
1	Use the  while pressing the  in the PV/SV display mode	The display unit proceeds to the Setup mode.
2	Press the  key until the display shows MANU .	
3	Use the  ,  keys to switch on Manual control function.	
4	Press the  key in the PV/SV display mode	The OUT/OFF Key has been assigned to be switching to Manual control instead of OUT/OFF function.
5	When automatic control is switched to manual control.	The display indicates the  .
6	Press the  ,  keys to change the output MV (Manipulated variables) and perform the control.	–









NOTE: Pressing the  key again, the unit reverts to the PV/SV display mode.

Lock

Setting Lock

When **Lock** is activated, you cannot change the parameters but the parameters can be displayed.

To set **Lock**, proceed as follows:

Step	Action
1	To enter the set value lock in the Auxiliary function setting mode, press the  and  keys for approximately 3 seconds.
2	Use the  key or the  key to select the following type of locks: <ul style="list-style-type: none"> ●  (Unlock): You can change all set values. ●  (Lock 1): You cannot change the set values. ●  (Lock 2): You can change only Main setting mode. ●  (Lock 3): You can change all set values except input type.
3	Press the  key to set the value.

NOTE: The changed values revert to their previous value after the power is turned off because they are not saved in the non-volatile memory.

NOTICE

UNINTENDED EQUIPMENT OPERATION

Do not change any setting item in Setup mode. If any item in Setup mode is changed, it will affect other setting items such as the SV and alarm value.











Failure to follow these instructions can result in equipment damage.

Setting the Temperature Controller

Input Setting

NOTE: Check the type of the input to be used before setting in the display unit.

You can set the input sensor type and the range for the input sensor in the Setup mode:

Step	Action	Remarks
1	Press the  key while pressing the  key for approximately 3 seconds in the PV/SV display mode.	The display unit proceeds to Setup mode. 
2	Press the  key to register the selected input type. Refer to the Input table below.	—
3	Use the  and  keys to set the scaling high and low limit values.	—  
4	Press the  key until the input scaling high limit or scaling low limit appears.	—
5	Press the  key to register the selected scaling high limit and scaling low limit values. NOTE: There is no standard range for DC voltage or DC current input (–2000...10000).	—

NOTE: You can use the PV scaling and decimal point location with the default factory settings.

Input Type Table







This table provides more information on input types, input scaling, decimal point location, and input codes:

Input Type		Input Code (°C)	Measurement Range [°C]	Input Code (°F)	Measurement Range [°F]
RTD	Pt100	Pt100C	-200.0...850.0	Pt100F	-320.0...1500.0
		Pt100C	-200...850	Pt100F	-320...1500
	JPt100	JPt100C	-200.0...500.0	JPt100F	-320.0...900.0
		JPt100C	-200...500	JPt100F	-320...900
Thermocouple	C(W/Re 5-26)	C000C	0...2315	C000F	32...4200
	J	J000C	-200...1000	J000F	-320...1800
	K	K000C	-200.0...400.0	K000F	-320.0...750.0
		K000C	-200...1370	K000F	-320...2500
	R	R000C	0...1760	R000F	32...3200
	B	b000C	0...1820	b000F	32...3300
	S	S000C	0...1760	S000F	32...3200
	T	T000C	-200.0...400.0	T000F	-320.0...750.0
	E	E000C	-200...800	E000F	-320...1500
	N	N000C	-200...1300	N000F	-320...2300
	PL-2	PL20C	0...1390	PL20F	32...2500

Input Type		Input Code (°C)	Measurement Range [°C]	Input Code (°F)	Measurement Range [°F]
DC voltage	0...1 Vdc	001V	-2000...10000 (Range where scaling is allowed)		
	0...5 Vdc	005V			
	1...5 Vdc	105V			
	0...10 Vdc	010V			
DC current ¹	0...20 mA dc	020A			
	4...20 mA dc	420A			
1 Connect 50 Ω shunt resistor when using DC input.					

Output Setting





You can define the output action either Reverse (Heating) or Direct (Cooling) control action in the Setup mode:

Step	Action	Remarks
1	Press the  key while pressing the  key for approximately 3 seconds in the PV/SV display mode.	The display unit proceeds to Setup mode. 
2	Press the  key until the display shows CoNT control action.	– 
3	Use the  and  keys to set the control output (OUT1/OUT2) either Heating or Cooling.	–

Alarm Setting



Selecting the Alarm Type

You can set the Alarm type in the Setup mode:

Step	Action	Remarks
1	Press the  key while pressing the  key for approximately 3 seconds in the PV/SV display mode.	The display unit proceeds to Setup mode.
2	Press the  key until the Alarm 1 or Alarm 2 type appears.	—
3	Use the  and  keys to select the desired alarm type. Refer to the Alarm selection table (<i>see page 59</i>).	—

Determining the Alarm Value

You can determine the alarm value in the Sub setting mode:

Step	Action	Remarks
1	Press the  key while pressing the  key for approximately 3 seconds in the PV/SV display mode.	The display unit proceeds to Sub setting mode.
2	Press the  key until the Alarm 1 value or Alarm 2 value appears. For more details, refer to the Alarm function (<i>see page 58</i>).	—

Operation Flowchart





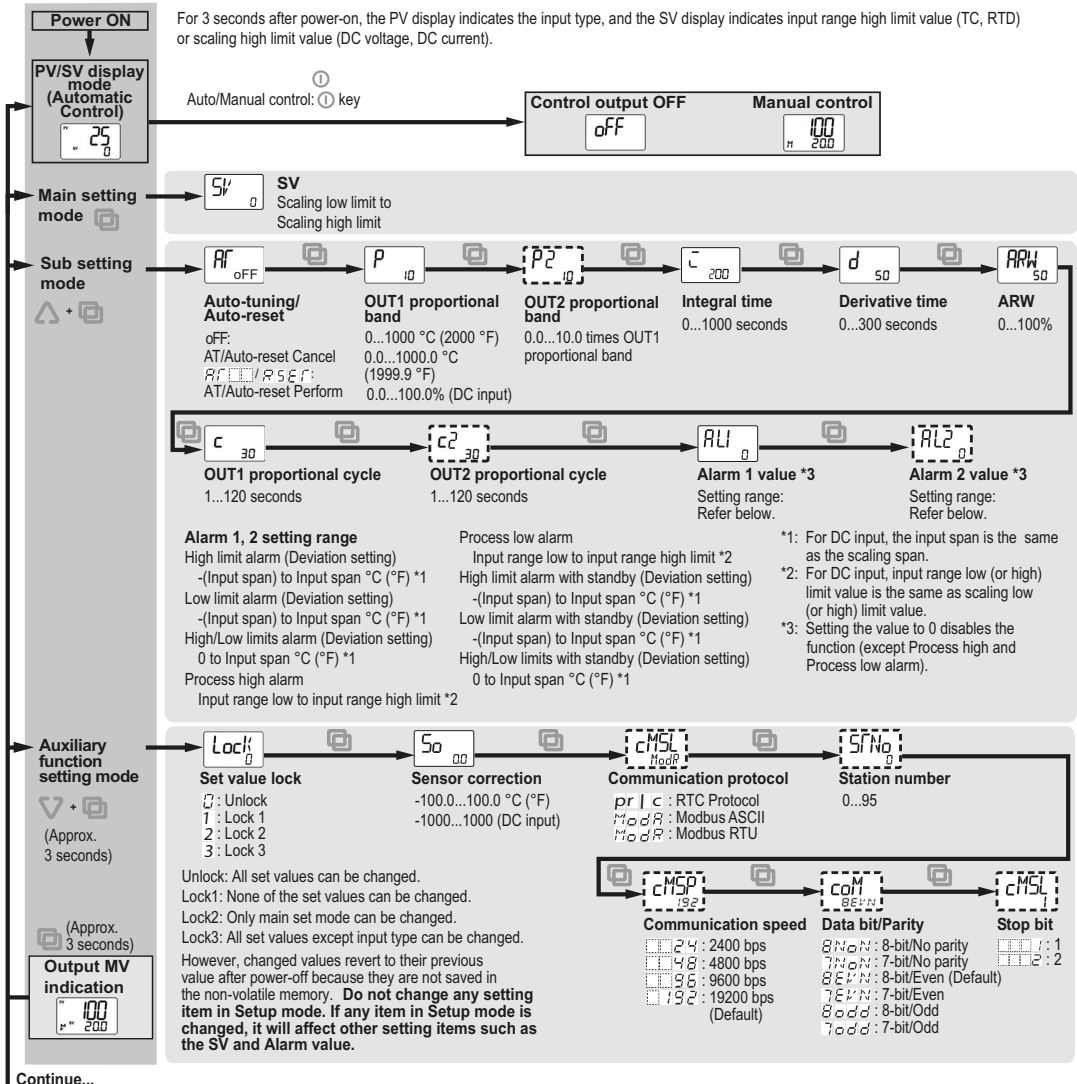



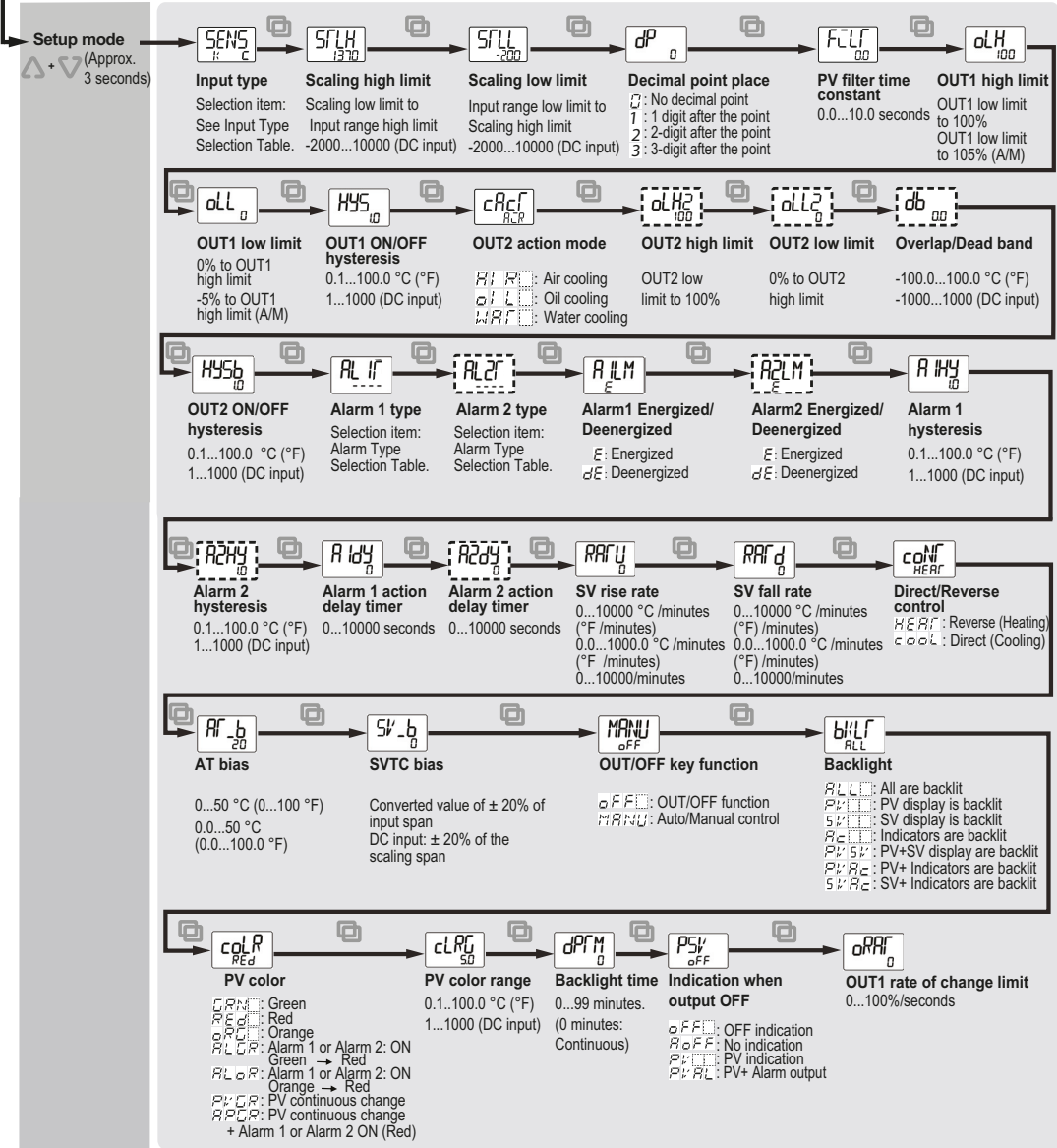





Parameters Overview

Refer to the following graphics for a detailed explanation of each parameter:



Continue...



- PV display indicates setting item characters, and SV display indicates default value.
- Setting items with dotted lines are optional and they appear only on selected models.
- Key operation
-   This means that if the  key is pressed, the unit proceeds to the next parameters menu.
-  +  : short press the  key while pressing the  key.
-  +  (Approx. 3 seconds): Press the  key for approx. 3 seconds while holding the  key.
-  +  (Approx. 3 seconds): Press the  key for approx. 3 seconds while holding down the  key.

NOTE: To return to PV/SV Display Mode from any setting mode, press and hold the  key for 3 seconds.

Parameters List

Main Setting Mode

Main setting mode is used to set the setpoint values.





The Main setting mode includes the following items:





Display	Parameter Name		Description	Setting Range	Factory Default Setting
	SV	Setpoint value	Sets SV.	Scaling low limit to scaling high limit	0 °C

Sub Setting Mode

The Sub setting mode includes the following items:

Display	Parameter Name		Description	Setting Range	Factory Default Setting
	AT	AT/Auto-Reset	<ul style="list-style-type: none"> Selects AT (Auto-Tuning) perform/cancel (PID control) or Auto-Reset perform/cancel (P, PD control). If the AT is canceled during the process, P, I, and D values revert to the values before AT was performed. AT will be forced to stop if it has not been completed within 4 hours. Auto-Reset is canceled in approximately 4 minutes. It cannot be released while performing this function. <p>NOTE: This is not available for ON/OFF or PI control action.</p>	OFF: AT/Auto-Reset Cancel AT/Auto-Reset: AT/Auto-Reset perform	OFF
<p>¹ This option is not available if Output 2 models are not selected.</p> <p>² This option is not available if Alarm 2 model is not selected.</p>					

Display	Parameter Name		Description	Setting Range	Factory Default Setting
	P	OUT1 proportional band	Sets the proportional band for OUT1. OUT1 becomes ON/OFF control when set to 0 or 0.0.	<ul style="list-style-type: none"> ● 0...1000 °C (2000 °F) ● TC or RTD input with decimal point: 0.0...1000.0 °C (1999.9 °F) ● DC voltage or current input: 0.0...100.0%) 	10 °C
	P2	OUT2 proportional band ¹	Sets the proportional band for OUT2. OUT2 becomes ON/OFF control when set to 0.0. NOTE: This is not available if Direct/Reverse control option is not added or if OUT1 is in ON/OFF control.	0.0...10.0 times OUT1 proportional band	1.0 times
	I	Integral time	Sets integral time for OUT1. Setting the value to 0 disables the function. You can perform Auto-Reset when PD is control action (I=0). NOTE: This is not available if OUT1 is in ON/OFF control.	0...1000 seconds	200 seconds
	d	derivative time	Sets derivative time for OUT1. Setting the value to 0 disables the function. NOTE: This is not available if OUT1 is in ON/OFF control.	0...300 seconds	50 seconds
	ARW	Anti-Reset Windup	Sets Anti-Reset Windup for OUT1. NOTE: This is available only when PID is control action.	0...100%	50%
<p>¹ This option is not available if Output 2 models are not selected.</p> <p>² This option is not available if Alarm 2 model is not selected.</p>					

Display	Parameter Name		Description	Setting Range	Factory Default Setting
	c	OUT1 proportional cycle	Sets proportional cycle for OUT1. For relay contact output, if the proportional cycle time is decreased, the frequency of the relay action increases, and the life of the relay contact is shortened. NOTE: This is not available if OUT1 is in ON/OFF control or DC current output type.	1...120 seconds	Relay contact: 30 seconds Non-contact voltage: 3 seconds
	c2	OUT2 proportional cycle ¹	Sets proportional cycle for OUT2. For relay contact output, if the proportional cycle time is decreased, the frequency of the relay action increases, and the life of the relay contact is shortened. NOTE: This is not available if Direct/Reverse control option is not added or if OUT2 is in ON/OFF control.	1...120 seconds	Relay contact: 30 seconds Non-contact voltage: 3 seconds
	AL1	Alarm 1 value	Sets action point for alarm 1 output. Setting the value to 0 or 0.0 disables the function (except Process high alarm and Process low alarm). NOTE: This is not available if no alarm action is selected during Alarm 1 type selection.	Refer to the Setting Range of Alarm value (see page 43).	0 °C
	AL2	Alarm 2 value ²	Sets action point for Alarm 2 output. Setting the value to 0 or 0.0 disables the function (except Process high alarm and Process low alarm). NOTE: This is not available if Alarm 2 (A2) option is not added or if no alarm action is selected during Alarm 2 type selection.	Refer to the Setting Range of Alarm value (see page 43).	0 °C
¹ This option is not available if Output 2 models are not selected. ² This option is not available if Alarm 2 model is not selected.					



Setting Range of Alarm Value

This table displays the setting range for various alarm types:





Alarm Type	Setting Range
High limit alarm	-(Input span) to input span °C (°F) ¹ .
Low limit alarm	-(Input span) to input span °C (°F) ¹ .
High/Low limits alarm	0 to input span °C (°F) ¹ .
High/Low limit range alarm	0 to input span °C (°F) ¹ .
Process high alarm	Input range low limit value to input range high limit value ² .
Process low alarm	Input range low limit value to input range low limit value ² .
High limit alarm with standby	-(Input span) to input span °C (°F) ¹ .
Low limit alarm with standby	-(Input span) to input span °C (°F) ¹ .
High/Low limits alarm with standby	0 to input span °C (°F) ¹ .
¹ For DC voltage and current input, the input span is the same as the scaling span. ² For DC voltage and current input, the Input range low limit or Input range high limit value is the same as scaling low limit or scaling high limit value.	

Auxiliary Function Setting Mode

The Auxiliary function setting mode includes the following items:









Display	Parameter Name		Description	Setting Range	Factory Default Setting
	Lock	Set value lock	Locks the set values to prevent detected errors setting. For more information, refer to the <i>LocK</i> (see page 32).	<ul style="list-style-type: none"> ● 0: (Unlock) ● 1: (Lock 1) ● 2: (Lock 2) ● 3: (Lock 3) 	- - - -
	So	Sensor correction	Sets the correction value for the sensor. This corrects the input value from the sensor. When a sensor is not able to set at the exact location where control is desired, the sensor measured temperature may deviate from the temperature in the controlled location. When controlling with plural controllers, sometimes the measured temperatures (input value) does not match due to the differences in sensor accuracy or dispersion of load capacities. In such a case, you can set the control at the desired temperature by adjusting the input value of sensors. PV after sensor correction = Current PV+ Sensor correction value	-100.0...100.0 °C (°F) DC voltage, current input: -1000...1000	0.0
	cMSL	Communication protocol ¹	Selects communication protocol.	The various communication protocols used are: <ul style="list-style-type: none"> ● PRTC ● Modbus ASCII mode ● Modbus RTU mode 	PRTC





¹ This option is not available if RS-485 communication models are not selected.





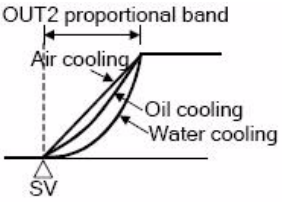

Display	Parameter Name		Description	Setting Range	Factory Default Setting
	STNo	Station number ¹	Sets the station number individually to each instrument when communicating by connecting plural instruments in serial communication.	0...95	1
	cMSP	Communication speed ¹	Selects a communication speed equal to that of the host computer.	The various communication speeds are: <ul style="list-style-type: none"> ● 2400 bps ● 4800 bps ● 9600 bps ● 19200 bps 	19200 bps
	coM	Data bit/Parity ¹	Selects data bit and parity.	The various data bits are: <ul style="list-style-type: none"> ● 8 bits/No parity ● 7 bits/No parity ● 8 bits/Even parity ● 7 bits/Even parity ● 8 bits/Odd parity ● 7 bits/Odd parity 	8 bits/Even parity
	cMSL	Stop bit ¹	Selects the stop bit.	The stop bits are: <ul style="list-style-type: none"> ● 1 ● 2 	1
¹ This option is not available if RS-485 communication models are not selected.					







Setup Mode



The Setup mode includes the following items:

Display	Parameter Name		Description	Setting Range	Factory Default Setting
	SENS	Input type	Sets the type of input sensor.	Refer to the Input Type table (see page 34)	K (°C)
	STLH	Scaling high limit	Sets scaling high limit value.	Scaling low limit value to input range high limit value DC voltage, current input: – 2000...10000	1370 °C
	STLL	scaling low limit value	Sets scaling low limit value.	Scaling low limit value to input range high limit value DC voltage, current input: – 2000...10000	–200 °C
	dP	Decimal point place	Selects decimal point place. NOTE: This is available only for DC input.	The various decimal point options are: <ul style="list-style-type: none"> ● No decimal point ● 1 digit after decimal point ● 2 digits after decimal point ● 3 digits after decimal point 	No decimal point
	FILT	PV filter time constant	Sets PV filter time constant. NOTE: If the value is set too high, it affects the control results due to the delay of response.	0.0...10.0 seconds	0.0 seconds
	oLH	OUT1 high limit ¹	Sets the high limit value of OUT1.	OUT1 low limit value to 100% DC current output: OUT1 low limit to 105%	100%
	oLL	OUT1 low limit ¹	Sets the low limit value of OUT1.	0% to OUT1 high limit value (DC current output type: –5% to OUT1 high limit value	0%
	HYS	OUT1 ON/OFF hysteresis ¹	Sets ON/OFF hysteresis for OUT1.	<ul style="list-style-type: none"> ● 0.1 to 100.0 °C (°F) ● DC voltage, current input: 1...1000 	1.0 °C
<p>¹ This option is not available if OUT1 is in ON/OFF control. ² This option is not available if the Direct/Reverse control option is not added or if OUT2 is in ON/OFF control. ³ This option is not available if no alarm action is selected during alarm 1 type selection. ⁴ This option is not available if alarm 2 (A2) option is not added or if no alarm action is selected during alarm 2 type selection.</p>					

Display	Parameter Name		Description	Setting Range	Factory Default Setting
	cAct	OUT2 action mode ²	Selects OUT2 action from air, oil, and water cooling.	<p>The various OUT2 action modes are:</p> <ul style="list-style-type: none"> ● Air cooling (linear characteristic) ● Oil cooling (1.5th power of the linear characteristic) ● Water cooling (second power of the linear characteristic) 	Air cooling
	oLH2	OUT2 high limit ²	Sets OUT2 high limit value.	OUT2 low limit value to 100%	100%
	oLL2	OUT2 low limit ²	Sets OUT2 low limit value.	0% to OUT2 high limit value	0%
	db	Overlap band/Dead band ²	<p>Sets the overlap band or dead band for OUT1 and OUT2.</p> <p>+Set value: Dead band, -Set value: Overlap band.</p>	<ul style="list-style-type: none"> ● -100.0...100.0 °C (°F) ● DC voltage, current input: – 1000...1000 	0.0 °C
	HYSb	OUT2 ON/OFF hysteresis ²¹	Sets ON/OFF hysteresis for OUT2.	<ul style="list-style-type: none"> ● 0.1...100.0 °C (°F) ● DC voltage, current input: 1...1000 	0.0 °C
<p>¹ This option is not available if OUT1 is in ON/OFF control.</p> <p>² This option is not available if the Direct/Reverse control option is not added or if OUT2 is in ON/OFF control.</p> <p>³ This option is not available if no alarm action is selected during alarm 1 type selection.</p> <p>⁴ This option is not available if alarm 2 (A2) option is not added or if no alarm action is selected during alarm 2 type selection.</p>					

Display	Parameter Name		Description	Setting Range	Factory Default Setting
	AL1T	Alarm 1 type	Selects an alarm 1 type. NOTE: If an alarm type is changed, the alarm set value becomes 0 (0.0).	The various alarm 1 types are: <ul style="list-style-type: none"> ● No alarm action ● High limit alarm ● Low limit alarm ● High/Low limits alarm ● High/Low limit range alarm ● Process high alarm ● Process low alarm ● High limit alarm with standby ● Low limit alarm with standby ● High/Low limits alarm with standby 	No alarm action
	AL2T	Alarm 2 (A2) type	Selects an alarm 2 type. NOTE: If an alarm type is changed, the alarm set value becomes 0 (0.0). NOTE: This is available only when alarm 2 (A2) option is added.	Selection items are the same as those of Alarm 1 type.	No alarm action
	A1LM	Alarm 1 Energized/De-energized ³	Selects Energized/De-energized status for alarm 1.	The types of alarm1 are: <ul style="list-style-type: none"> ● Energized ● Deenergized 	Energized
	A2LM	Alarm 2 Energized/De-energized ⁴	Selects Energized/De-energized status for alarm 2.	Selection items are the same as those of Alarm 1 Energized/De-energized selection.	Energized
	A1HY	Alarm 1 hysteresis ³	Sets hysteresis for alarm 1.	<ul style="list-style-type: none"> ● 0.1...100.0 °C (°F) ● DC voltage, current input: 1...1000 	1.0 °C
	A2HY	Alarm 2 hysteresis ⁴	Sets hysteresis for alarm 2.	<ul style="list-style-type: none"> ● 0.1...100.0 °C (°F) ● DC voltage, current input: 1...1000 	1.0 °C
<p>¹ This option is not available if OUT1 is in ON/OFF control.</p> <p>² This option is not available if the Direct/Reverse control option is not added or if OUT2 is in ON/OFF control.</p> <p>³ This option is not available if no alarm action is selected during alarm 1 type selection.</p> <p>⁴ This option is not available if alarm 2 (A2) option is not added or if no alarm action is selected during alarm 2 type selection.</p>					

Display	Parameter Name		Description	Setting Range	Factory Default Setting
	A1dY	Alarm 1 action delayed timer ³	Sets Alarm 1 action delayed timer. When setting time has elapsed after the input enters the alarm output range, the alarm is activated.	0...10000 seconds	0 seconds
	A2dY	Alarm 2 action delayed timer ⁴	Sets Alarm 2 action delayed timer. When setting time has elapsed after the input enters the alarm output range, the alarm is activated.	0...10000 seconds	0 seconds
	RATU	SV rise rate	Sets SV rise rate (rising value for 1 minute). NOTE: Setting to 0 disables the function.	<ul style="list-style-type: none"> Setting range: 0...10000° C /minute (° F/minute) Thermocouple, RTD input with a decimal point: 0.0...1000.0° C/minute (° F/minute) DC voltage, current input: 0...10000/minute 	0 °C
	RATd	SV fall rate	Sets SV fall rate (falling value for 1 minute). NOTE: Setting to 0 disables the function.	<ul style="list-style-type: none"> Setting range: 0...10000° C /minute (° F/minute) Thermocouple, RTD input with a decimal point: 0.0...1000.0° C/minute (° F/minute) DC voltage, current input: 0...10000/min 	0 °C
	coNT	Direct/Reverse action	Selects either Heating (reverse) or Cooling (direct) control	The types of control action are: <ul style="list-style-type: none"> Heating (reverse) Cooling (direct) 	Heating (reverse)
	AT_b	AT bias	Sets bias value during AT (Auto-Tuning). NOTE: This is not available for DC input.	0...50 °C (32...100 °F)	20 °C
<p>¹ This option is not available if OUT1 is in ON/OFF control.</p> <p>² This option is not available if the Direct/Reverse control option is not added or if OUT2 is in ON/OFF control.</p> <p>³ This option is not available if no alarm action is selected during alarm 1 type selection.</p> <p>⁴ This option is not available if alarm 2 (A2) option is not added or if no alarm action is selected during alarm 2 type selection.</p>					



Display	Parameter Name		Description	Setting Range	Factory Default Setting
	SV_b	SVTC bias	SV adds SVTC bias value to the value received by the SVTC command. NOTE: This is available only when the RS-485 communication option is added.	<ul style="list-style-type: none"> ● Setting range: Converted value of 20% of the input span. ● DC voltage, current input: 20% of the scaling span. 	
	MANU	OUT/OFF Key	Selects whether OUT/OFF key is used for control output OFF function or for auto/manual control function.	The OUT/OFF key functions are: <ul style="list-style-type: none"> ● OUT/OFF function ● Auto/Manual control function 	OUT/OFF function
	bKLT	Backlight selection	Selects the display to backlight.	The various backlight selections are: <ul style="list-style-type: none"> ● All are backlit. ● Only PV display is backlit. ● Only SV display is backlit. ● Only action indicators are backlit. ● PV and SV displays are backlit. ● PV display and action indicators are backlit. ● SV display and action indicators are backlit. 	All are backlit

¹ This option is not available if OUT1 is in ON/OFF control.

² This option is not available if the Direct/Reverse control option is not added or if OUT2 is in ON/OFF control.

³ This option is not available if no alarm action is selected during alarm 1 type selection.

⁴ This option is not available if alarm 2 (A2) option is not added or if no alarm action is selected during alarm 2 type selection.

Display	Parameter Name		Description	Setting Range	Factory Default Setting
	coLR	PV color	Selects PV display color.	<p>The various display colors are:</p> <ul style="list-style-type: none"> ● Green ● Red ● Orange ● Alarm 1 or Alarm 2 is ON: From green to red. ● Alarm 1 or Alarm 2 is ON: From Orange to red. ● PV color changes continuously ● PV color changes continuously + Alarm 1 or Alarm 2 is ON (red). <p>For more information, refer to the PV display color Selection (see page 60).</p>	Red
	cLRG	PV color range	Selects PV color range.	<p>The various PV color range are:</p> <ul style="list-style-type: none"> ● 0.1...100.0 °C (°F) ● 1...1000 (DC input) 	–
	dPTM	Backlight time	<p>Sets time to backlight from no operation status until backlight is switched off. The backlight remains ON when set to 0. Backlight relights by pressing any key while backlight is OFF.</p>	0...99 minutes	0 minutes
	PSV	Indication selection when control output OFF	Selects the indication when control output is OFF.	<p>Various types of indications are:</p> <ul style="list-style-type: none"> ● OFF indication ● No indication ● PV indication ● PV indication + Alarm 1 and Alarm 2 output active <p>NOTE: The default indication type is OFF indication.</p>	OFF indication
<p>¹ This option is not available if OUT1 is in ON/OFF control.</p> <p>² This option is not available if the Direct/Reverse control option is not added or if OUT2 is in ON/OFF control.</p> <p>³ This option is not available if no alarm action is selected during alarm 1 type selection.</p> <p>⁴ This option is not available if alarm 2 (A2) option is not added or if no alarm action is selected during alarm 2 type selection.</p>					

Display	Parameter Name		Description	Setting Range	Factory Default Setting
	oRAT	OUT1 rate-of-change	Sets changing value of OUT1 MV (manipulated variable) for 1 second. NOTE: This is not available if OUT1 is in ON/OFF control, or when set to 0.	0...100 %/second	0%/second
<p>¹ This option is not available if OUT1 is in ON/OFF control.</p> <p>² This option is not available if the Direct/Reverse control option is not added or if OUT2 is in ON/OFF control.</p> <p>³ This option is not available if no alarm action is selected during alarm 1 type selection.</p> <p>⁴ This option is not available if alarm 2 (A2) option is not added or if no alarm action is selected during alarm 2 type selection.</p>					

Main Functions of RTC48



4

What Is in This Chapter?

This chapter contains the following topics:

Topic	Page
Auto-Tuning	54
Control Actions	57
Alarm Functions	58
PV Color Display Function	60
OUT1 Rate of Change	62

Auto-Tuning

Overview

To set each value of P, I, D, and ARW automatically, the AT process must be made to fluctuate to obtain an optimal value. One of 3 types of fluctuation below is automatically selected.

For DC voltage, current input, the AT process fluctuates around the SV for below conditions of 1, 2, and 3.

NOTICE

UNINTENDED EQUIPMENT OPERATION

- Perform the AT during the trial run.
- During the AT, none of the setting items can be set.
- If power interruption occurs during the AT, the tuning stops.
- Sometimes the AT process does not fluctuate if AT is performed at or near room temperature. Therefore AT may not finish normally.

Failure to follow these instructions can result in equipment damage.

1. In case of a large difference between the SV and processing temperature as the temperature is rising

When AT bias is set to 20 °C, the AT process fluctuates at the temperature 20 °C lower than the SV.

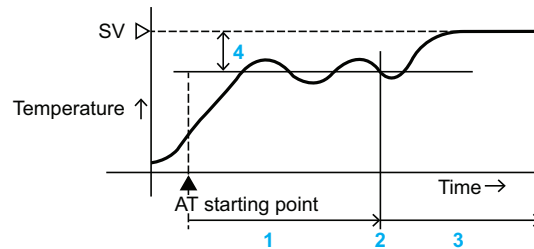

- 1 Calculating PID constant
- 2 PID constant calculated
- 3 Controlled by the PID constant set by AT
- 4 AT bias value

2. When the control is stable

The AT process fluctuates around the SV.

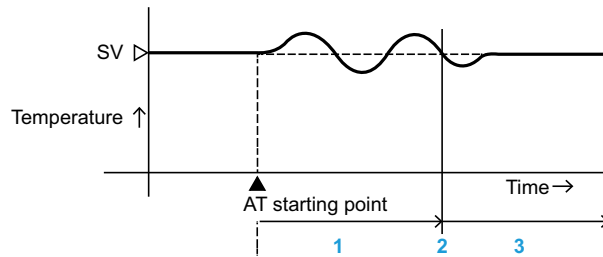

- 1 Calculating PID constant
- 2 PID constant calculated
- 3 Controlled by the PID constant set by AT

3. In case of a large difference between the SV and processing temperature as the temperature is falling



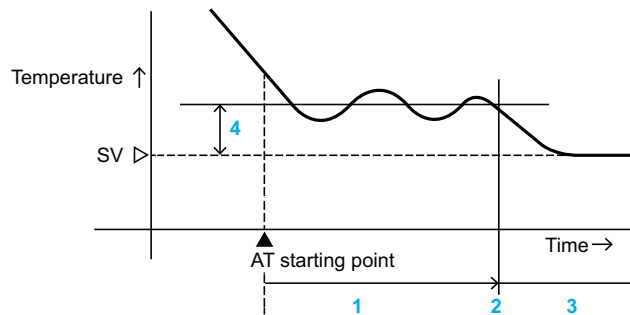





When AT bias is set to 20 °C, the AT process fluctuates at the temperature 20 °C higher than the SV.



- 1 Calculating PID constant
- 2 PID constant calculated
- 3 Controlled by the PID constant set by AT
- 4 AT bias value

Auto-tuning Perform/Cancel Mode (PID Control)

To auto-tune the perform/cancel mode, proceed as follows:

Step	Action	Remarks
1	Press the  key while pressing the  key in the PV/SV display mode.	The display unit proceeds to Sub setting mode. 
2	Use the  key to select AT Perform or use the  key to select AT oFF.	— 
3	Press the  key to confirm the setting.	The display unit reverts to PV/SV display mode. 
4	While AT is performing, the AT indicator flashes, and it goes off if AT is canceled.	— 

Control Actions

Overview

The following control actions are performed:

- Direct/Reverse operation
- ON/OFF control
- PI, PID, PD, P controls

Direct/Reverse Operation

Reverse operation is used to control the heating function. Refer to the Direct/Reverse control action (*see page 46*) for more details.

Direct operation is used to implement cooling function.

ON/OFF Control

Acts as an ON/OFF control when proportional band is set to 0 or 0.0. ON/OFF control switches the control output to ON (100%) or OFF (0%) according to the size relationship of PV and SV. Refer to the Sub setting mode parameters (*see page 40*) for more details.

PI, PID, PD, and P Controls

The control switches to PID control when auto-perform function is selected. The control switches to PI control when derivative time is set to 0. The control switches to PD control when integral time is set to 0. The control switches to PD control when derivative and integral time are set to 0. Refer to the Sub setting mode parameters (*see page 40*) for more details.

Alarm Functions

Overview

The following alarm functions are performed:

- Alarm type
- Alarm energized/de-energized
- Alarm hysteresis
- Alarm action delayed timer

Alarm Type

It allows you to select the pre-defined alarm types based on the requirement. The alarm type includes high limit alarm, high/low limits alarm, process high alarm, and so on. Refer to the Setup mode parameters (*see page 46*) for more details.

Alarm Energized/De-energized

When the Alarm type Energized (NoML) option is selected, the alarm output is conductive (ON) while the alarm output indicator is lit.

The alarm output is not conductive (OFF) while the alarm output indicator is not lit.

When the Alarm type Deenergized (REVS) option is selected, the alarm output is conductive (FF) while the alarm output indicator is lit.

The alarm output is conductive (ON) while the alarm output indicator is not lit.

Refer to the Setup mode parameters (*see page 46*) for more details.

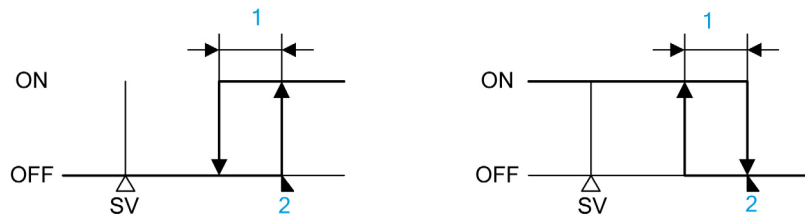

- 1 Alarm 1 or Alarm 2 Hysteresis
- 2 Alarm 1 or Alarm 2 value

Alarm Hysteresis

It enables you to set the hysteresis for the alarms. Refer to the Setup mode parameters (*see page 46*) for more details.

Alarm Action Delayed Timer

When setting time has elapsed after the input enters the alarm output range, the alarm is activated. Refer to the Setup mode parameters (*see page 46*) for more details.

Alarm Type Selection

NOTE: Default OFF, no alarm action

This table provides more information on alarm types and codes:

	$H\Box\Box\Box$ High limit alarm	$L\Box\Box\Box$ Low limit alarm	$HL\Box\Box$ High/Low limits alarm
Alarm action			
	$W\Box\Box\Box$ High/Low limit range alarm	$R\Box\Box\Box \rightarrow R5\Box\Box\Box$ Process high alarm	$RR5\Box\Box$ Process low alarm
Alarm action			
	$H\Box\Box\Box\Box$ High limit alarm with standby	$L\Box\Box\Box\Box$ Low limit alarm with standby	$HL\Box\Box\Box$ High/Low limits alarm with standby
Alarm action			

PV Color Display Function

Overview

The following PV display color are performed:

- constant color selection (Green, Red or Orange)
- Changing continuously the PV color
- Changing continuously the PV color when Alarm 1 or Alarm 2 is ON.

PV Color Display

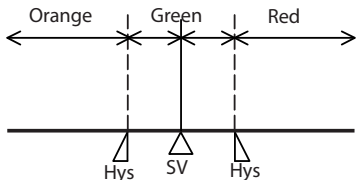
Display	PV color selection	PV color display
$\overline{GR}\overline{R}$	Green	green
$\overline{RE}\overline{d}$	Red	red
\overline{oRG}	Orange	orange
\overline{RLGR}	When Alarm 1 or Alarm 2 is ON Green →Red	When Alarm 1 or Alarm 2 OFF: Green When Alarm 1 or Alarm 2 is ON, the PV color turns from green to red.
\overline{RLoR}	When Alarm 1 or Alarm 2 is ON Orange →Red	When Alarm 1 or Alarm 2 OFF: Orange When Alarm 1 or Alarm 2 is ON, the PV color turns from orange to red.
\overline{PVGR}	PV color changes continuously Orange →Green →Red	<p>PV color changes depending on the color range setting:</p> <ul style="list-style-type: none"> • PV is lower than [SV-PV color range]: orange • PV is within [SV±PV color range]: green • PV is higher than [SV+PV color range]: red  <p>Hys Set point of PV color range</p>

Display	PV color selection	PV color display
<p>APGR</p>	<p>PV color changes continuously Orange → Green → Red and at the same time Alarm 1 or Alarm 2 is ON (Red)</p>	<p>When Alarm 1 or Alarm 2 is ON, PV display turns red.</p> <ul style="list-style-type: none"> ● PV is lower than [SV-PV color range]: orange ● PV is within [SV±PV color range]: green ● PV is higher than [SV+PV color range]: red ● Alarm 1 or Alarm 2 is ON: red <p>Hys Set point of PV color range AL1 Alarm 1 value (High limit alarm) AL2 Alarm 2 value (Low limit alarm)</p>

OUT1 Rate of Change

Overview

This control is suitable for high temperature heaters (which are made from molybdenum, tungsten or platinum, etc., and used at approximately. 1500...1800° C) which are easily burnt out from turning on electricity rapidly.

The following below show the normal output operation and the output when OUT1 Rate of Change is set:

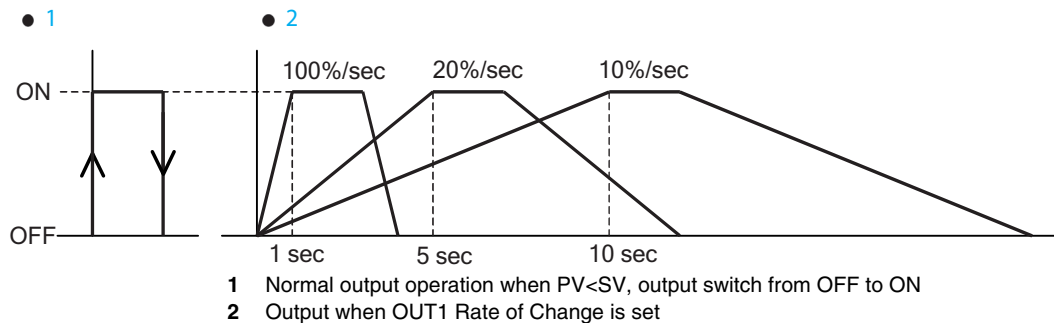

Appendices



RTC48 Error Messages

5



Troubleshooting

LED Indication

Problem	Presumed Cause and Solution
□ FF: nothing or PV is indicated on the PV display.	<ul style="list-style-type: none">● Control output OFF function is working. Press the  key for approximately 1 second to release the function.
- - - - is flashing on the PV display.	<ul style="list-style-type: none">● Burnout of thermocouple, RTD, or disconnection of DC voltage (0...1 Vdc). Change each sensor.● To check whether the sensor is burnt out, proceed as follows:<ul style="list-style-type: none">● Thermocouple If the input terminals of the instrument are shorted, and if a value around room temperature is indicated, the instrument is likely to be operating normally. However, the sensor may be burnt out.● RTD If approximately 100 of resistance is connected to the input terminals between A-B of the instrument and between B-B is shorted, and if a value around 0 °C (32 °F) is indicated, the instrument is likely to be operating normally. However, the sensor may be burnt out.● DC voltage (0...1 Vdc) If the input terminals of the instrument are shorted, and if a scaling low limit value is indicated, the instrument is likely to be operating normally. However, the signal wire may be disconnected.● Check whether the input terminals of thermocouple, RTD, or DC voltage (0...1 Vdc) are securely mounted to the instrument input terminal or not. Connect the sensor terminals to the instrument input terminals securely.

Problem	Presumed Cause and Solution
<p>- - - - is flashing on the PV display.</p>	<ul style="list-style-type: none"> ● Check whether the input signal wire for DC voltage (1...5 Vdc) or DC current (4...20 mA DC) is disconnected. ● To check whether the input signal wire is disconnected, proceed as follows: <ul style="list-style-type: none"> ● DC voltage (1...5 Vdc) If the input to the input terminals of the instrument is 1 Vdc, and if a scaling low limit value is indicated, the instrument is likely to be operating normally. However, the signal wire may be disconnected. ● DC current (4...20 mA DC) If the input to the input terminals of the instrument is 4 mA DC and if a scaling low limit value is indicated, the instrument is likely to be operating normally. However, the signal wire may be disconnected. ● Check whether the input signal wire for DC voltage (1...5 Vdc) or DC current (4 to 20 mA DC) is securely connected to the instrument input terminals. ● Check if polarity of thermocouple or compensating lead wire is correct. ● Check whether codes (A, B, B) of RTD agree with the instrument terminals or not.
<p>The PV display keeps indicating the value which is set during scaling low limit setting.</p>	<ul style="list-style-type: none"> ● Check whether the input signal wire for DC voltage (0...5 Vdc, 0...10 Vdc) and DC current (0...20 mA DC) is disconnected. ● To check whether the input signal wire is disconnected, proceed as follows: <ul style="list-style-type: none"> ● DC voltage (0...5 Vdc, 0...10 Vdc) If the input to the input terminals of the instrument is 0 Vdc and if a scaling low limit value is indicated, the instrument is likely to be operating normally. However, the signal wire may be disconnected. ● DC current (0...20 mA DC) If the input to the input terminals of the instrument is 0 mA DC and if a scaling low limit value is indicated, the instrument is likely to be operating normally. However, the signal wire may be disconnected. ● Check whether the input terminals for DC voltage (0... 5 Vdc,0...10 Vdc) or DC current (0...20 mA DC) are securely connected to the instrument input terminals or not.
<p>The indication of PV display is irregular or unstable.</p>	<ul style="list-style-type: none"> ● Check whether sensor input unit or sensor temperature unit (°C or °F) is correct. Select the sensor input unit or sensor temperature unit (°C or °F) properly. ● Sensor correcting value is unsuitable. Set it to a suitable value. ● Check whether the specification of the sensor is correct or not. ● AC leaks into the sensor circuit. Use an ungrounded type sensor. ● There may be equipment that interferes with or makes noise near the controller. Keep equipment that interferes with or makes noise away from the controller.
<p><i>Err 1</i> is indicated on the PV display.</p>	<ul style="list-style-type: none"> ● Internal memory is defective. Contact Schneider Electric.

Key Operation

Problem	Presumed Cause and Solution
<ul style="list-style-type: none"> Unable to set the SV, P, I, D, proportional cycle, or alarm value. The values do not change by  ,  keys. 	<ul style="list-style-type: none"> Set value lock (Lock 1 or Lock 2) is selected. Release the lock during the set value lock selection. AT or auto-reset is performing. In the case of AT, cancel AT. It takes approximately 4 minutes until auto-reset is finished.
<p>The setting indication does not change in the input range even if the keys are pressed, and new values are unable to be set.</p>	<ul style="list-style-type: none"> Scaling high limit or scaling low limit value in the Setup mode may be set at the point where the value does not change. Set it to a suitable value while in the Setup mode.

Control

Problem	Presumed Cause and Solution
<p>Temperature does not rise.</p>	<ul style="list-style-type: none"> Sensor is out of order. Replace the sensor. Check whether the sensor or control output terminals are securely mounted to the instrument input terminals. Ensure that the sensor or control output terminals are mounted to the instrument input terminals securely. Check whether the wiring of sensor or control output terminals is correct.
<p>The control output remains in an ON status.</p>	<ul style="list-style-type: none"> OUT1 low limit value or OUT2 low limit value is set to 100% or higher in Setup mode. Set it to a suitable value.
<p>The control output remains in an OFF status.</p>	<ul style="list-style-type: none"> OUT1 high limit value or OUT2 high limit value is set to 0% or less in Setup mode. Set it to a suitable value.

For all other detected faults, contact Schneider Electric.

Index

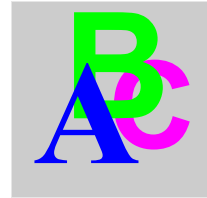

B

basic operations of RTC48, *31*

C

control references and characteristics of RTC48, *12*

D

dimensions of RTC48, *21*
dismounting the RTC48, *23*
display of RTC48, *12*

H

hardware
 electrical characteristics of RTC48, *18*
 environmental characteristics of RTC48,
 19
how to configure RTC48 using front panel,
30

I

installation precautions of RTC48, *20*

K

Key lock, *32*

M

main specifications of RTC48, *15*
mounting the RTC48, *23*

R

RTCCOV
 Terminal cover, *27*

S

setting the temperature controller, *33*

T

troubleshooting, *65*

W

wiring of RTC48, *24*

